

Jupiter[®]

Model JM4

HART[®] Installation and Operating Manual

Software v1.x

Magnetostrictive Level Transmitter

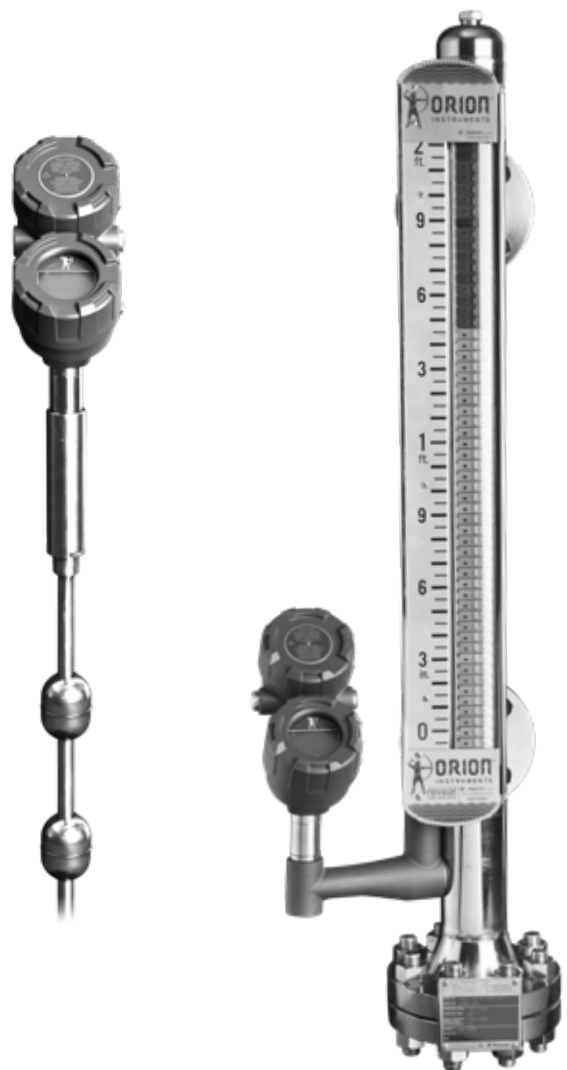
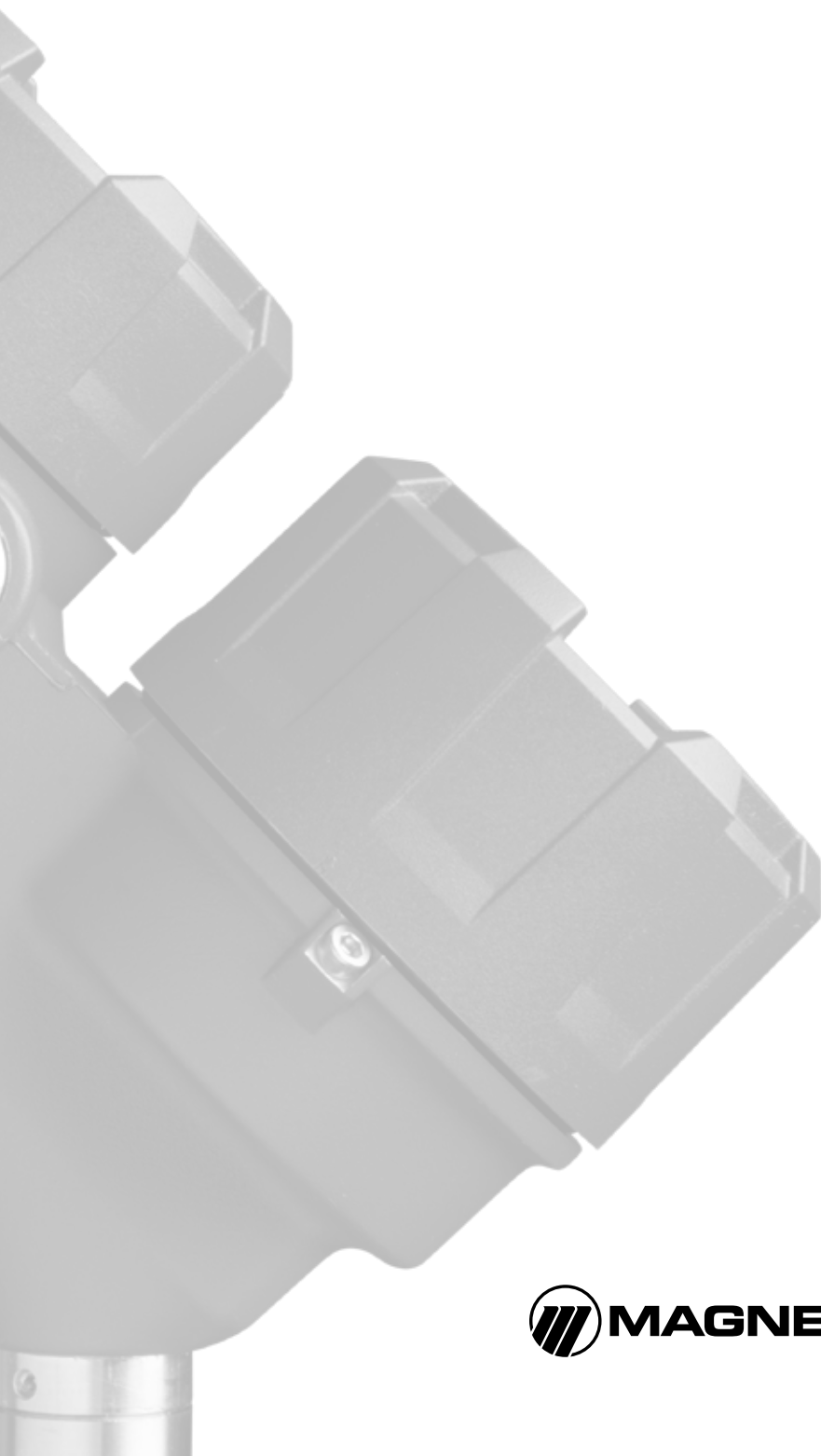

Read this Manual Before Installing

This manual provides information on the Jupiter® magnetostrictive transmitter. It is important that all instructions are read carefully and followed in sequence. Detailed instructions are included in the Installation section of this manual.

Conventions Used in this Manual

Certain conventions are used in this manual to convey specific types of information. General technical material, support data, and safety information are presented in narrative form. The following styles are used for notes, cautions, and warnings.

Notes

Notes contain information that augments or clarifies an operating step. Notes do not normally contain actions. They follow the procedural steps to which they refer.

Cautions

Cautions alert the technician to special conditions that could injure personnel, damage equipment, or reduce a component's mechanical integrity. Cautions are also used to alert the technician to unsafe practices or the need for special protective equipment or specific materials. In this manual, a caution box indicates a potentially hazardous situation which, if not avoided, may result in minor or moderate injury.

Warnings

Warnings identify potentially dangerous situations or serious hazards. In this manual, a warning indicates an imminently hazardous situation which, if not avoided, could result in serious injury or death.

Safety Messages

Follow all standard industry procedures for servicing electrical equipment when working with or around high voltage. Always shut off the power supply before touching any components.

WARNING! Explosion hazard. Do not connect or disconnect designs rated Explosion proof or Non-incendive unless power has been switched off and/or the area is known to be non-hazardous.

Low Voltage Directive

For use in Installation Category II, Pollution Degree 2. If equipment is used in a manner not specified by the manufacturer, protection provided by the equipment may be impaired.

Notice of Trademark, Copyright, and Limitations

Orion & Orion logotype, Magnetrol & Magnetrol logotype, and Jupiter are registered trademarks of Magnetrol International.

Copyright © 2019 Magnetrol International.
All rights reserved.

Performance specifications are effective with date of issue and are subject to change without notice. Magnetrol reserves the right to make changes to the product described in this manual at any time without notice. Magnetrol makes no warranty with respect to the accuracy of the information in this manual.

Warranty

All Magnetrol/Orion electronic level and flow controls are warranted free of defects in materials or workmanship for eighteen months from the date of original factory shipment.

If returned within the warranty period; and, upon factory inspection of the control, the cause of the claim is determined to be covered under the warranty; then, Magnetrol/Orion will repair or replace the control at no cost to the purchaser (or owner) other than transportation.

Magnetrol/Orion shall not be liable for misapplication, labor claims, direct or consequential damage or expense arising from the installation or use of equipment. There are no other warranties expressed or implied, except special written warranties covering some Magnetrol/Orion products.

Quality Assurance

The quality assurance system in place at Magnetrol guarantees the highest level of quality throughout the company. Magnetrol is committed to providing full customer satisfaction both in quality products and quality service.

Magnetrol's quality assurance system is registered to ISO 9001 affirming its commitment to known international quality standards providing the strongest assurance of product/service quality available.

Jupiter® JM4 Magnetostrictive Transmitter

Table of Contents

1.0 Installation	
1.1 Installation Prep	4
1.1.1 Factory Mounting & Pre-configuration	4
1.1.2 Unpacking	4
1.1.3 Electrostatic Discharge Handling	4
1.1.4 Site Preparation (Power Supply)	5
1.1.5 Equipment and Tools	5
1.1.6 Mounting Transmitter Head	5
1.1.7 Remote Mount Transmitter Head	6
1.1.8 Hi-Temp Configurations and Temp Limits	6
1.2 Mounting for External Mount	6
1.2.1 Available Configurations	6
1.2.2 Securing the Transmitter to the MLI	7
1.2.3 Installation on Atlas vs. Aurora	8
1.2.4 Insulation	8
1.2.5 Vibration Kit	8
1.3 Mounting for Direct Insertion	9
1.3.1 Available Configurations	9
1.3.2 Float Installation	9
1.3.3 Centering Disc	10
1.4 Wiring	10
1.4.1 General Purpose or Non-Incendive (Cl I, Div. 2)	10
1.4.2 Intrinsically Safe	11
1.4.3 Explosion Proof	11
1.5 Configuration	12
1.5.1 Bench Configuration	12
1.5.2 Menu Navigation and Data Entry	12
1.5.2.1 Navigating the Menu	13
1.5.2.2 Data Selection	13
1.5.2.3 Entering Numeric Data Using Digit Entry	13
1.5.2.4 Entering Numeric Data Using Increment/Decrement	14
1.5.2.5 Entering Character Data	14
1.5.3 Password Protection	14
1.5.4 Model JM4 Menu: Step-By-Step Procedure	15
1.5.5 Auto-Configuration/Reset New Probe Diagnostic	17
1.5.6 Model JM4 Configuration Menu – Device Setup	18
1.6 Configuration using HART®	23
1.6.1 Connections	23
1.6.2 HART Communicator Display	23
1.6.3 HART Revision Table	23
1.6.4 HART Menu – Model JM4	23
1.6.5 HART Menu Items	27
2.0 Reference Information	
2.1 Description	38
2.2 Theory of Operation	38
2.3 Troubleshooting	38
2.3.1 Diagnostics (Namur NE 107)	39
2.3.2 Troubleshooting Table	41
2.3.3 Status Messages	42
2.3.4 Diagnostic Help	43
2.4 Configuration Information	44
2.4.1 Volumetric Capability	44
2.4.1.1 Configuration Using Built-In Vessel Types	44
2.4.1.2 Configuration Using Custom Table	46
2.4.2 Reset Function	47
2.4.3 Additional Diagnostic/Troubleshooting Capabilities	47
2.4.3.1 Event History	47
2.4.3.2 Context-sensitive Help	47
2.4.3.3 Trend Data	47
2.5 Agency Approvals	48
2.5.1 Agency Specifications – FM/CSA Intrinsically Safe Installation	50
2.5.2 Agency Specifications – FM/CSA Intrinsically Safe FOUNDATION fieldbus™ Installation	51
2.6 Specifications	52
2.6.1 Functional/Physical	52
2.6.2 Probe Selection Guide	53
2.6.3 Probe Specifications	53
2.6.4 Physical Specifications – Transmitter	54
2.6.5 Power Supply Requirements	56
2.6.5.1 Safe Operating Area	56
2.6.5.2 Terminal Voltage	56
2.7 Model Number	57
2.8 Parts	63
2.8.1 Replacement Parts	63
Glossary	64

1.0 Installation

Caution: If equipment is used in a manner not specified by manufacturer, protection provided by equipment may be impaired

This section provides detailed procedures for properly installing, wiring, configuring and, if needed, troubleshooting the Jupiter magnetostrictive level transmitter.

In most cases, externally mounted units will be shipped from the factory attached to the Orion Instruments magnetic level indicator.

1.1 Installation Prep

1.1.1 Factory Mounting & Pre-configuration

All Jupiter Model JM4 transmitters sold with Orion Instruments® magnetic level indicators (MLIs) are shipped pre-mounted and pre-configured. The span for 4-20 mA and HART or FOUNDATION fieldbus™ is set to the span of the process connections on the MLI. For instructions on how to re-configure the transmitter, see Section 1.5 Configuration.

1.1.2 Unpacking

Unpack the instrument carefully. Inspect all units for damage. Report any concealed damage to carrier within 24 hours. Check the contents against the packing slip and purchase order. Check and record the serial number for future reference when ordering parts.

Caution: Do not discard the shipping container until all parts are accounted for and inspected.

1.1.3 Electrostatic Discharge Handling

Magnetrol/Orion's electronic instruments are manufactured to the highest quality standards. These instruments use electronic components that may be damaged by static electricity present in most work environments.

The following steps are recommended to reduce the risk of component failure due to electrostatic discharge.

- Ship and store circuit boards in anti-static bags. If an antistatic bag is not available, wrap the board in aluminum foil. Do not place boards on foam packing materials.
- Use a grounding wrist strap when installing and removing circuit boards. A grounded workstation is recommended.
- Handle circuit boards only by the edges. Do not touch components or connector pins.



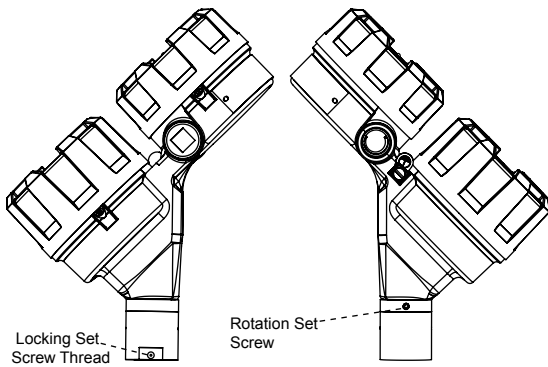

Fig. 1-1
Side Views of Transmitter Head

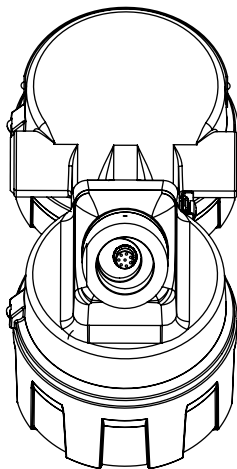

Fig. 1-2
Transmitter Head Connection From Below

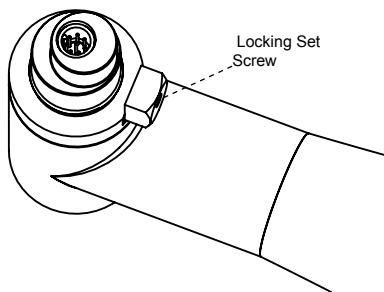

Fig. 1-3
Probe Connection From Above

- Make sure that all electrical connections are completely made and none are partial or floating. Ground all equipment to a reliable earth ground.

1.1.4 Site Preparation (Power Supply)

Each Jupiter magnetostrictive transmitter is built to match the specifications required within the defined model number. Wiring terminations will need to be made and the configuration will need to be accomplished.

Ensure that the power to be supplied to the instrument is the same voltage (24 VDC) as ordered with the instrument, and that the wiring between the power supply and the Jupiter transmitter is correct for the type of installation.

NOTE: Applying incorrect voltage will damage the unit.

When installing the Jupiter transmitter in a general purpose or hazardous area, all local, state, and federal regulations and guidelines must be observed. See *Wiring, Section 1.4*.

1.1.5 Equipment and Tools

To attach a Jupiter transmitter to an existing MLI or direct insertion model, you may need the following tools:

- $\frac{5}{16}$ " Nut-Driver (for tightening the mounting clamps).
- Screwdriver and assorted hand tools for making conduit and electrical connections.
- Tape measure or ruler if configuring via Set 4 mA and Set 20 mA display screens.
- Digital multimeter or DVM to troubleshoot supply voltage problems.
- 2.5 mm Allen key to tighten transmitter to probe connection.

1.1.6 Mounting Transmitter Head

To attach the JM4 transmitter head to the probe, place the female transmitter connection (Figure 1-2) over the male probe connection (Figure 1-3), and rotate until the pins slide into place. Use a 2.5 mm Allen key to hand tighten set screw (Figure 1-1) to secure the transmitter head in place. Once secured, rotate display until its in the desired position. If transmitter head rotation is not desired, tighten the rotation screw, also with a 2.5 mm Allen key.

Caution: In case of potential head space constraints, ensure that an extra 1.5 inches is available in addition to the height of the transmitter head (and flange, where applicable). This extra space is required for attaching or removing the transmitter head when necessary.

NOTE: For dimensions, see Section 2.6.4.

1.1.7 Remote Mount Transmitter Head

For applications with possible clearance or transmitter accessibility issues, the JM4 is available with a remote mount transmitter head. This transmitter head comes with a 3 or 12 ft (0.91 or 3.66 m) heavily shielded cable and can be mounted onto nearby objects.

NOTE: Not available for Explosion proof units.

1.1.8 Hi-Temp Configurations and Temp Limits

The hi-temp JM4 transmitter is capable of operating in process temperatures between -50 and +800 °F (-46 to +427 °C). Keep in mind that the hi-temp JM4 has a neck extending 9¼" (23.5 cm) from the probe to the transmitter head (as opposed to 5¼" or 13.3 cm for the standard JM4), so height restrictions should be considered before installing.

1.2 Mounting for External Mount

1.2.1 Available Configurations

The externally mounted Jupiter Model JM4 transmitter is available with a variety of configurations and mounting options. These include (in order from left to right in Figure 1-4) top-mount, top-mount offset, bottom-mount offset. All of these configurations are available with one or two magnetic floats (two floats are necessary to measure total AND interface level).

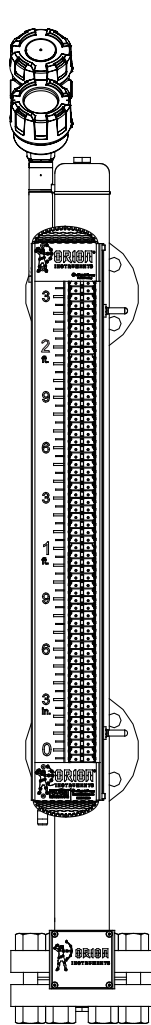

Fig. 1-4a
Top Mount

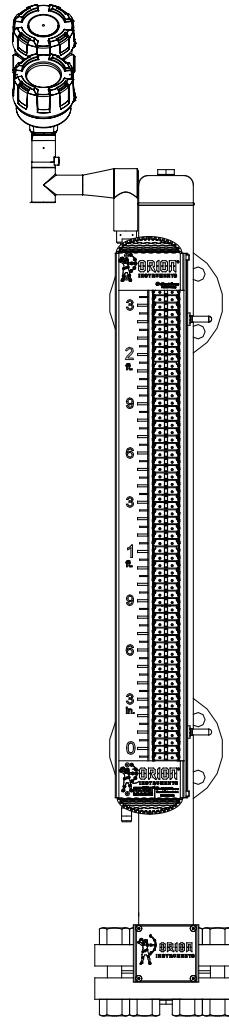

Fig. 1-4b
Top Mount Offset

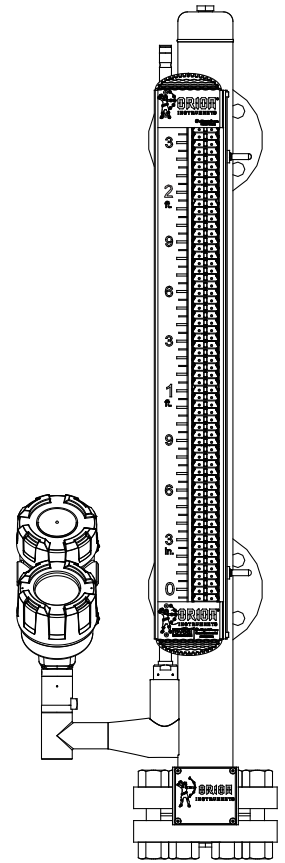

Fig. 1-4c
Bottom Mount

1.2.2 Securing the Transmitter to the MLI

Each externally mounted JM4 transmitter is provided with a set of clamps (two or more, depending on probe length) for securing to the MLI chamber. If the JM4 was ordered with an Orion MLI, then it will come pre-mounted, but if the transmitter was ordered separately, then it can be secured using the following steps.

1. Place the Jupiter transmitter and mounting clamps in a convenient location.
2. Position the Jupiter transmitter on the side of the MLI where it will be attached. Mark the location and the exact area where the clamps will be attached to hold the Jupiter in place. The probe should extend above and below the process connections to ensure full coverage of the desired measuring span.
3. Attach the lower clamp and tighten so that it remains in place, but loose enough so that there is still room to place the guide tab from the Jupiter between the inside of the clamp and the outer diameter of the MLI chamber.

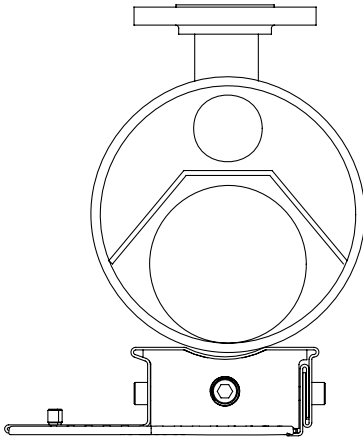

Fig. 1-5a
Aurora® Cross-section

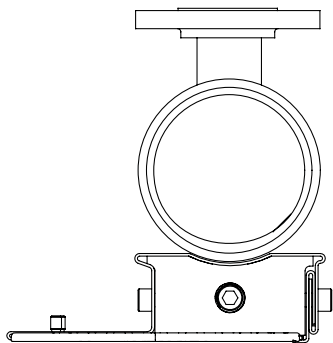

Fig. 1-5b
Atlas™ Cross-section

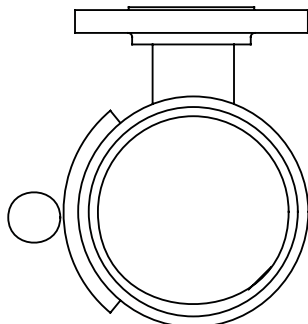

Fig. 1-6a
Insulation Pad

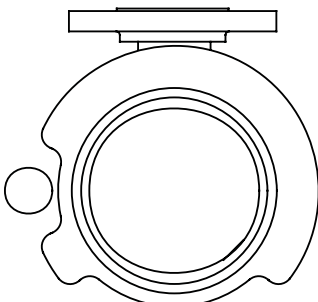

Fig. 1-6b
Insulation Blanket

4. The upper clamp will need to be open to a large enough diameter to be able to mount to the MLI as well as the probe. The upper clamp should be positioned just above the 3/4" NPT threads.
5. Mount the Jupiter guide pin in the lower clamp and tighten. If necessary, use strapping tape to temporarily hold in place on the MLI.
6. Position the upper clamp to attach the unit to the MLI and tighten.
7. Discard any tape temporarily holding the Jupiter to the MLI.

1.2.3 Installation on Atlas vs. Aurora

When mounting the Jupiter model JM4 transmitter onto the outside of an MLI, float proximity must be taken into account. For an Orion Atlas MLI, the distance between the float and the chamber wall is the same all around the chamber, so the transmitter could be placed anywhere. However, for an Aurora MLI, the chamber is divided into two sections: the float section and the magnetostrictive probe/gas-bypass section (Figure 1-5a). Because of this, the transmitter must specifically placed as close to the float section as possible, to ensure proper signal strength.

1.2.4 Insulation

For personnel and equipment protection, high-temperature insulation is available with JM4 transmitters. Insulation pads provide protection for the transmitter only, whereas insulation blankets cover the entire chamber, which can help protect personnel from elevated temperatures.

To install a JM4 with an insulation pad, first secure pad to the chamber, then secure the transmitter over the pad (Figure 1-6a). To install a JM4 with an insulation blanket, secure the blanket over the chamber, then be sure to place the transmitter in the smaller of the two grooves, leaving the larger groove for visual indication (Figure 1-6b).

1.2.5 Vibration Kit

For applications in which vibration is an issue, the Jupiter model JM4 is available with a vibration absorption kit.

1.3 Mounting for Direct Insertion

1.3.1 Available Configurations

The direct insertion version of the JM4 transmitter has several available configurations as well. As with external-mount, direct insertion JM4 is available with one or two floats. JM4 can be installed in external chambers or into the main vessel. It is also available with a centering disc and/or stilling well to keep the probe in position.

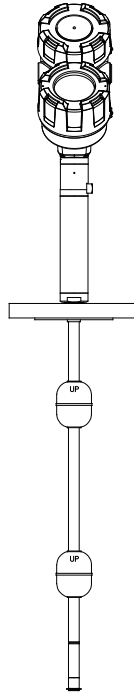

Fig. 1-7a. Direct Insertion,
Two Floats

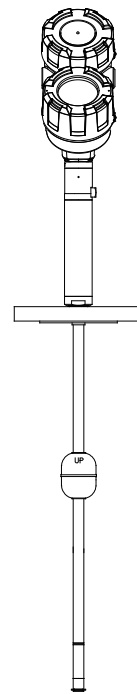

Fig. 1-7b. Direct Insertion,
One Float

1.3.2 Float Installation

Use caution when handling probes to ensure probe is not bent during installation. A bend in the probe may prevent float from traveling freely up and down the probe.

1. Verify float will pass through vessel opening, if not, it will be necessary to attach the float after the probe is installed.
2. Carefully insert probe into vessel and thread or bolt to the mating connection as appropriate.
3. The float is held on the probe by a C-clip inserted into a groove machined into the tip of the probe. The float is attached or removed by removing and reinserting the C-clip. To ensure proper float orientation, the float is marked "UP".

NOTE: When placing floats on probe, make sure the side marked "UP" is facing up. If there are two floats, make sure the total level float (the lighter float) is on top, and the interface float (the heavier float) is on the bottom.

1.3.3 Centering Disc

All Jupiter model JM4 transmitters that come with a stilling well are also provided with a centering disc to prevent the probe from making contact with the stilling well.

1.4 Wiring

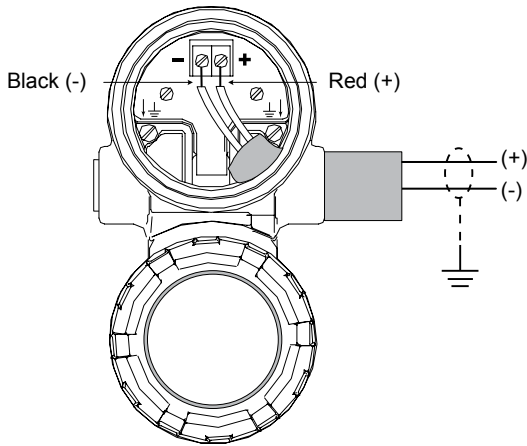

Fig. 1-8
Wiring Diagram

Caution: HART version of the JUPITER Model JM4 transmitter operate at voltages of 11-28.6 VDC, while FOUNDATION fieldbus versions operate at 9-17.5 VDC. Higher voltages will damage the transmitter.

Wiring connections between the power supply and the Jupiter Model JM4 transmitter should be made using 18-22 AWG shielded twisted pair instrument cable. Connections are made to the terminal strip and the ground connections within the top enclosure compartment.

The directions for wiring the Jupiter transmitter depend on the applications:

- General Purpose or Non-Incendive (Cl I, Div. 2)
- Intrinsically Safe
- Explosion Proof

WARNING! Explosion hazard. Do not connect or disconnect designs rated Explosion proof or Non-incendive unless power has been switched off and/or the area is known to be non-hazardous.

1.4.1 General Purpose or Non-Incendive (Cl I, Div. 2)

A general purpose installation does not have flammable media present.

Areas rated Non-Incendive (Cl I, Div. 2) have flammable media present only under abnormal conditions.

No special electrical connections are required.

Caution: If flammable media is contained in the vessel, the transmitter must be installed per Class I, Div 1 standards of area classification.

To install General Purpose or Non-Incendive wiring:

1. Remove the cover from the wiring compartment of the transmitter. Install the conduit plug in the unused opening and use PTFE tape/sealant to ensure a liquid-tight connection.
2. Install a conduit fitting and pull the supply wires.
3. Connect shield to an earth ground at power supply.
4. Connect an earth ground wire to the nearest green ground screw (not shown in illustration).
5. Connect the positive supply wire to the (+) terminal and the negative supply wire to the (-) terminal.

-
6. Replace and tighten the cover to the transmitter wiring compartment before applying power.

1.4.2 Intrinsically Safe

An Intrinsically Safe (IS) installation potentially has flammable media present. An approved IS barrier must be installed in the non-hazardous (safe) area to limit the available energy out to the hazardous area. *See Agency Specifications Section 2.5.1.*

To install Intrinsically Safe wiring:

1. Ensure that the IS barrier is properly installed in the safe area (refer to local plant or facility procedures). Complete the wiring from the power supply to the barrier and from the barrier to the JM4 transmitter.
2. Remove the cover from the wiring compartment of the transmitter. Install the conduit plug in the unused opening and use PTFE tape/sealant to ensure a liquid-tight connection.
3. Install a conduit fitting and pull the supply wires.
4. Connect shield to an earth ground at power supply.
5. Connect an earth ground wire to the nearest green ground screw (not shown in illustration).
6. Connect the positive supply wire to the (+) terminal and the negative supply wire to the (-) terminal.
7. Replace and tighten the cover to the wiring compartment of the transmitter before applying power.

1.4.3 Explosion Proof

Explosion Proof (also referred to as XP or flameproof) is another method of designing equipment for installation into hazardous areas. A hazardous location is an area in which flammable gases or vapors are (or may be) present in the air in quantities sufficient to produce explosive or ignitable mixtures

The wiring for the transmitter must be contained in Explosion Proof conduit extending into the safe area.

- Due to the specialized design of the JM4 transmitter, no Explosion Proof conduit fitting (EY seal) is required within 18" of the transmitter.
- An Explosion Proof conduit fitting (EY seal) is required between the hazardous and safe areas.

To install Explosion Proof transmitter:

1. Install Explosion Proof conduit from the safe area to the conduit connection of the JM4 transmitter (refer to the local plant or facility procedures).
2. Remove the cover from the wiring compartment of the transmitter.
3. Connect shield to an earth ground at the power supply.

4. Connect an Earth ground wire to the nearest green ground screw per local electrical code (not shown in illustration).
5. Connect the positive supply wire to the (+) terminal and the negative supply wire to the (-) terminal.
6. Replace and tighten the cover to the wiring compartment of the transmitter before applying power.

1.5 Configuration

Although the Jupiter Model JM4 transmitter can be delivered pre-configured from the factory, it can also be easily reconfigured in the shop or at the installation using the local LCD/Keypad, HART communicator, or PACTware/DTM. Bench configuration provides a convenient and efficient way to set up the transmitter before going to the tank site to complete the installation.

Before configuring any transmitter, collect all operating parameters information.

Apply power to the transmitter and follow the step-by-step procedures below for the menu-driven transmitter display. *See Menu Navigation and Data Entry Section 1.5.2*

Information on configuring the transmitter using a HART communicator is given in Section 1.6.

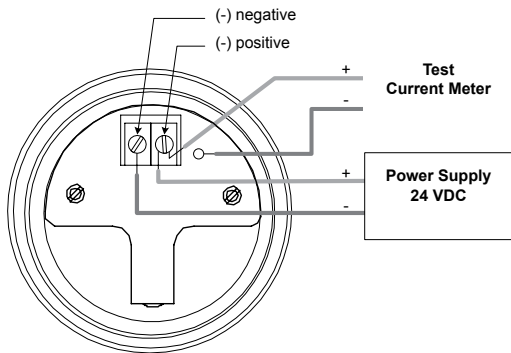

Fig. 1-9
G.P./I.S./Explosion Proof Model

1.5.1 Bench Configuration

The Jupiter Model JM4 transmitter can be easily configured at a test bench by connecting a standard 24 VDC power supply directly to the transmitter terminals as shown in the accompanying diagram. An optional digital multimeter is shown in the event that mA current measurements are desired.

NOTE: Current measurements taken at these test points are an approximate value. Accurate current readings should be taken with the digital multimeter directly in series with the loop.

NOTE: When using a HART communicator for configuration, a minimum 250-ohm line load resistance is required. Refer to your HART communicator manual for additional information.

NOTE: The transmitter can be configured without the probe. Please disregard the “No Probe” diagnostic indicator that will appear.

1.5.2 Menu Navigation and Data Entry

The four push buttons offer various forms of functionality for navigation and data entry.

The Model JM4 user interface is hierarchical in nature, best described as a tree structure. Each level in the tree contains one or more items. Items are either menu labels or parameter names.

- Menu labels are presented in all capital letters
- Parameters are capital words

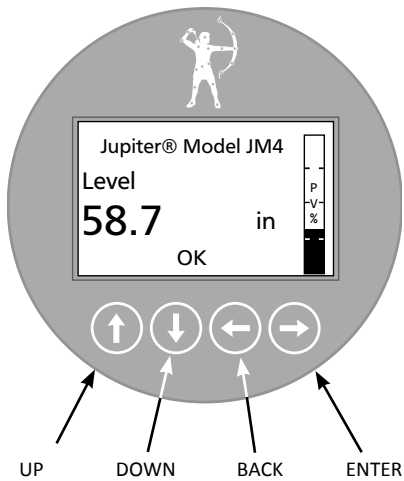

Fig 1-10
Home Screen

1.5.2.1 Navigating the Menu

- ↑ **UP** moves to the previous item in the menu branch.
- ↓ **DOWN** moves to the next item in the menu branch.
- ↶ **BACK** moves back one level to the previous (higher) branch item.
- ↵ **ENTER** enters into the lower level branch or switches to the entry mode. Holding the ENTER down on any highlighted menu name or parameter will show help text for the item.

1.5.2.2 Data Selection

This method is used for selecting configuration data from a specific list.

- ↑ **UP** and ↓ **DOWN** to navigate the menu and highlight the item of interest.
- ↵ **ENTER** allows modification of that selection.
- ↑ **UP** and ↓ **DOWN** to choose new data selection.
- ↵ **ENTER** to confirm selection.

Use ↶ **BACK** (Escape) key at any time to abort the procedure and escape to previous branch item.

1.5.2.3 Entering Numeric Data Using Digit Entry

This method is used to input numeric data, e.g., Probe Length, set 4mA and set 20mA.





Push Button		Keystroke Action
↑	Up	Moves up to the next highest digit (0,1,2,3,....,9 or decimal point). If held down the digits scroll until the push button is released.
↓	Down	Moves down to the next lowest digit (0,1,2,3,....,9 or decimal point). If held down the digits scroll until the push button is released.
↶	Back	Moves the cursor to the left and deletes a digit. If the cursor is already at the leftmost position, then the screen is exited without changing the previously saved value.
↵	Enter	Moves the cursor to the right. If the cursor is located at a blank character position, the new value is saved.

All numeric values are left-justified, and new values are entered from left to right. A decimal point can be entered after the first digit is entered, such that .9 is entered as 0.9.

Some configuration parameters can have a negative value. In this case, the leftmost position is reversed for the sign (either “-” for a negative value, or “+” for a positive value).

1.5.2.4 Entering Numeric Data Using Increment/Decrement





Use this method to input the following data into parameters such as Damping and Failure Alarm.

Push Button		Keystroke Action
	Up	Increments the displayed value. If held down the digits scroll until the push button is released. Depending on which screen is being revised, the increment amount may increase by a factor of 10 after the value has been incremented 10 times.
	Down	Decrements the displayed value. If held down the digits scroll until the push button is released. Depending on which screen is being revised, the decrement amount may increase by a factor of 10 after the value has been decremented 10 times.
	Back	Returns to the previous menu without changing the original value, which is immediately redisplayed.
	Enter	Accepts the displayed value and returns to the previous menu.

1.5.2.5 Entering Character Data

This method is used for parameters requiring alphanumeric character entry, such as for entering tags, etc.

General Menu Notes:

Push Button		Keystroke Action
	Up	Moves to the previous character (Z...Y...X...W). If held down, the characters scroll until the push button is released.
	Down	Moves to the next item character (A...B...C...D). If held down, the characters scroll until the push button is released.
	Back	Moves the cursor back to the left. If the cursor is already at the leftmost position, then the screen is exited without changing the original tag characters.
	Enter	Moves the cursor forward to the right. If the cursor is at the rightmost position, then the new tag is saved.

1.5.3 Password Protection

The Jupiter Model JM4 transmitter has three levels of password protection to restrict access to certain portions of the menu structure that affect the operation of the system. The user password can be changed to any numerical value up to 59999. When the transmitter is programmed for password protection, a password is required whenever configuration values are changed.

User Password

The User Password allows the customer to limit access to the basic configuration parameters.

The default User Password installed in the transmitter at the factory is 0. With a password of 0, the transmitter is no longer password protected, and any value in the basic user menus can be adjusted without entering a confirming password.

NOTE: If a User Password is not known or has been misplaced, the menu item New Password in the DEVICE SETUP/ADVANCED CONFIG menu displays an encrypted value representing the present password. Contact Technical Support with this encrypted password to retrieve the original User Password.

Advanced Password

Certain portions of the menu structure that contain more advanced parameters are further protected by an Advanced Password.

This password will be provided when necessary, by Factory technical support.

Factory Password

Calibration-related and other factory settings are further protected by a Factory Password.

1.5.4 Model JM4 Menu: Step-By-Step Procedure

The following tables provide a complete explanation of the software menus displayed by the JM4 transmitter. The menu layout is similar between the local Keypad/LCD interface, the DD, and the DTM.

Use these tables as a step-by-step guide to configure the transmitter based on the desired measurement type from the following selections:

- **Level Only**
- **Interface Only**
- **Interface & Level**
- **Level & Volume**

HOME SCREEN

The Home Screen consists of a “slide show” sequence of Measured Values screens which are rotated at 2-second intervals. Each Home Measured Value screen can present up to four information items:

- **HART® Tag**
- **Measured Value**
Label, Numerical Value, Units
- **Status**
Will be displayed as text or optionally with NAMUR NE 107 symbol
- **Primary Value Bar Graph** (shown in %)

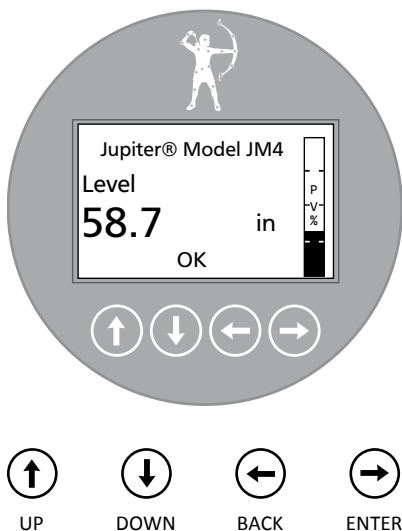

Fig 1-11
Home Screen

The Home Screen presentation can be customized by viewing or hiding some of these items. See DISPLAY CONFIG under the DEVICE SETUP menu in Section 1.6.4 HART Menu - Model JM4.

Figure 1-9 is an example of a Home Screen for a Model JM4 configured for a Level Only application.

MAIN MENU

Pressing any key on the Home Screen will present the Main Menu, consisting of three basic menu labels shown in all capital letters.

- **DEVICE SETUP**
- **DIAGNOSTICS**
- **MEASURED VALUES**

As shown, the reverse video represents a cursor identifying the selected item, which will appear in reverse video on the LCD. The actions of the keys at this point are:

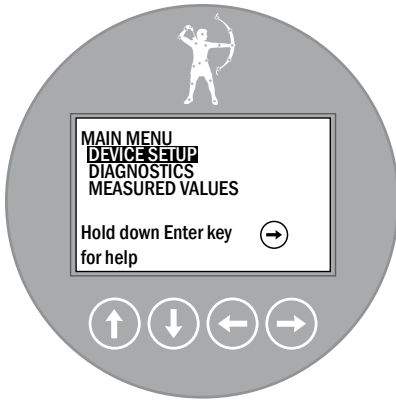

Fig. 1-12. Main Menu

Push Button		Keystroke Action
⬆	Up	No action, as the cursor is already at the first item in the MAIN MENU
⬇	Down	Moves the cursor to DIAGNOSTICS
⬅	Back	Moves back to HOME SCREEN, the level above MAIN MENU
➡	Enter	Presents the selected item, DEVICE SETUP

- NOTES: 1. Items and parameters that are shown in lower level menus will depend on the Measurement Type chosen. Those parameters not applicable to the present Measurement Type will be hidden.
2. Holding down the Enter key when the cursor is highlighted over a parameter or menu will provide additional information about that item.

DEVICE SETUP

Choosing DEVICE SETUP from the MAIN MENU will result in an LCD presentation as shown at left.

The small down arrow shown at the right hand side of the screen is the indication that more items are available below and can be accessed by pressing the DOWN key.

Section 1.6.4 shows the entire tree menu for the Model JM4 DEVICE SETUP Menu.

MEASURED VALUES

Allows the user to scroll through all of the available measured values for the measurement type chosen.

1.5.5 Auto-Configuration/Reset New Probe Diagnostic ■

Each JM4 probe has its own set of configuration parameters stored inside. With these parameters, it is possible to auto-configure the transmitter using the following steps.

1. Connect the new probe to the transmitter.
2. The home screen will display a “Device Failure: New Probe” message in alternating video on the screen.
3. Pressing any key will bring the user directly to the “Clear New Probe Diagnostic” line in the Device Setup\Advanced Config\Probe Params menu.

NOTE: Clear New Probe Diagnostic will replace current settings with those needed to properly use the newly attached probe. Before executing, consider saving a file containing your current Basic Config, I/O Config, and Local Display Config settings for reference using the DTM or a HART communicator.

4. Press the Enter key to initiate the clearing process.

NOTE: After running the diagnostic, check PV, measurement type, and 4 and 20 mA set points to be sure these parameters are appropriately set for the application.

1.5.6 Model JM4 Configuration Menu – Device Setup

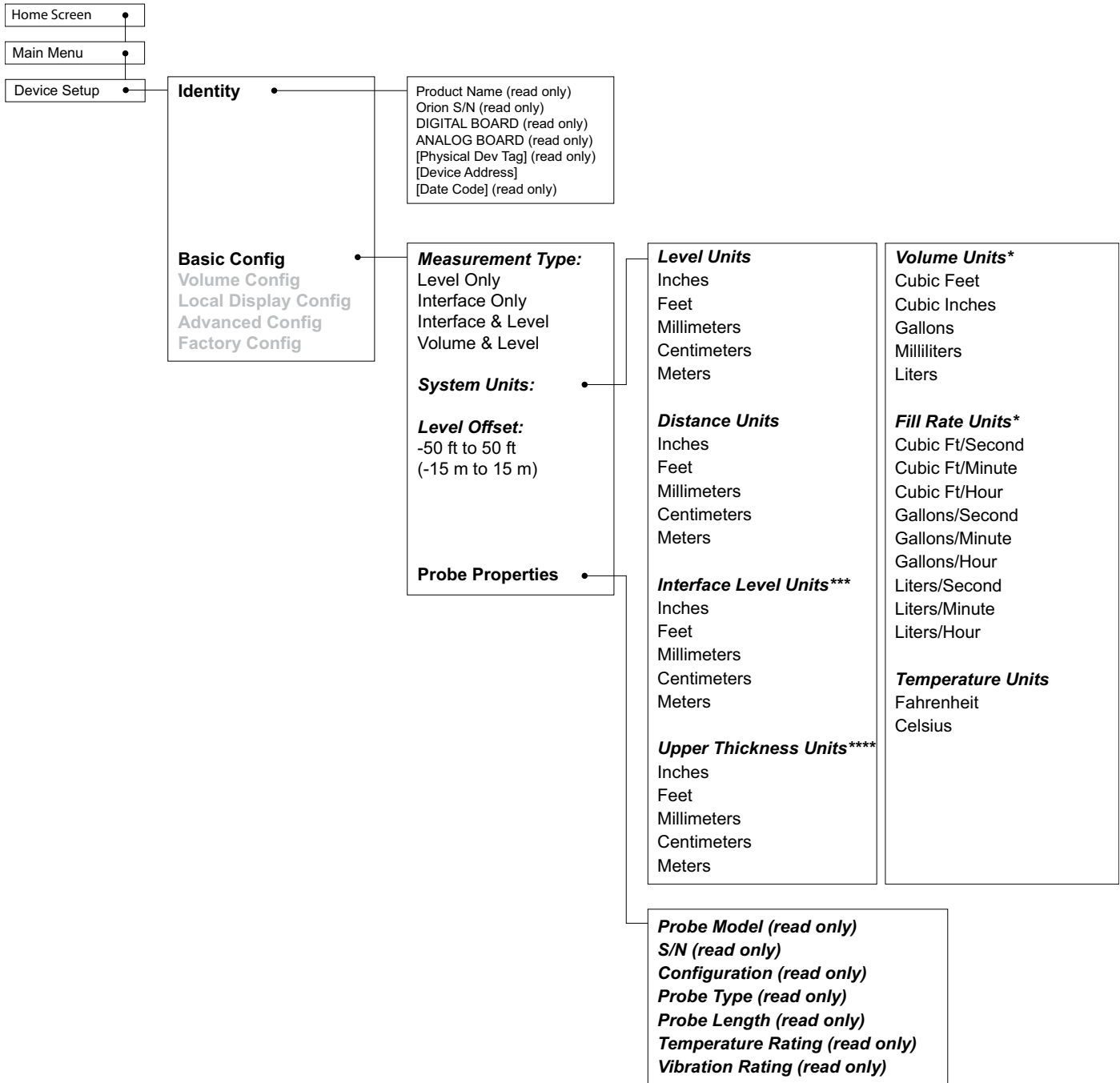

* Only available when Measurement Type = Volume & Level

** Not available when Measurement Type = Interface Only

*** Only available when Measurement Type = Interface Only or Interface & Level

**** Only Available when Measurement Type = Interface & Level

1.5.6 Model JM4 Configuration Menu – Device Setup

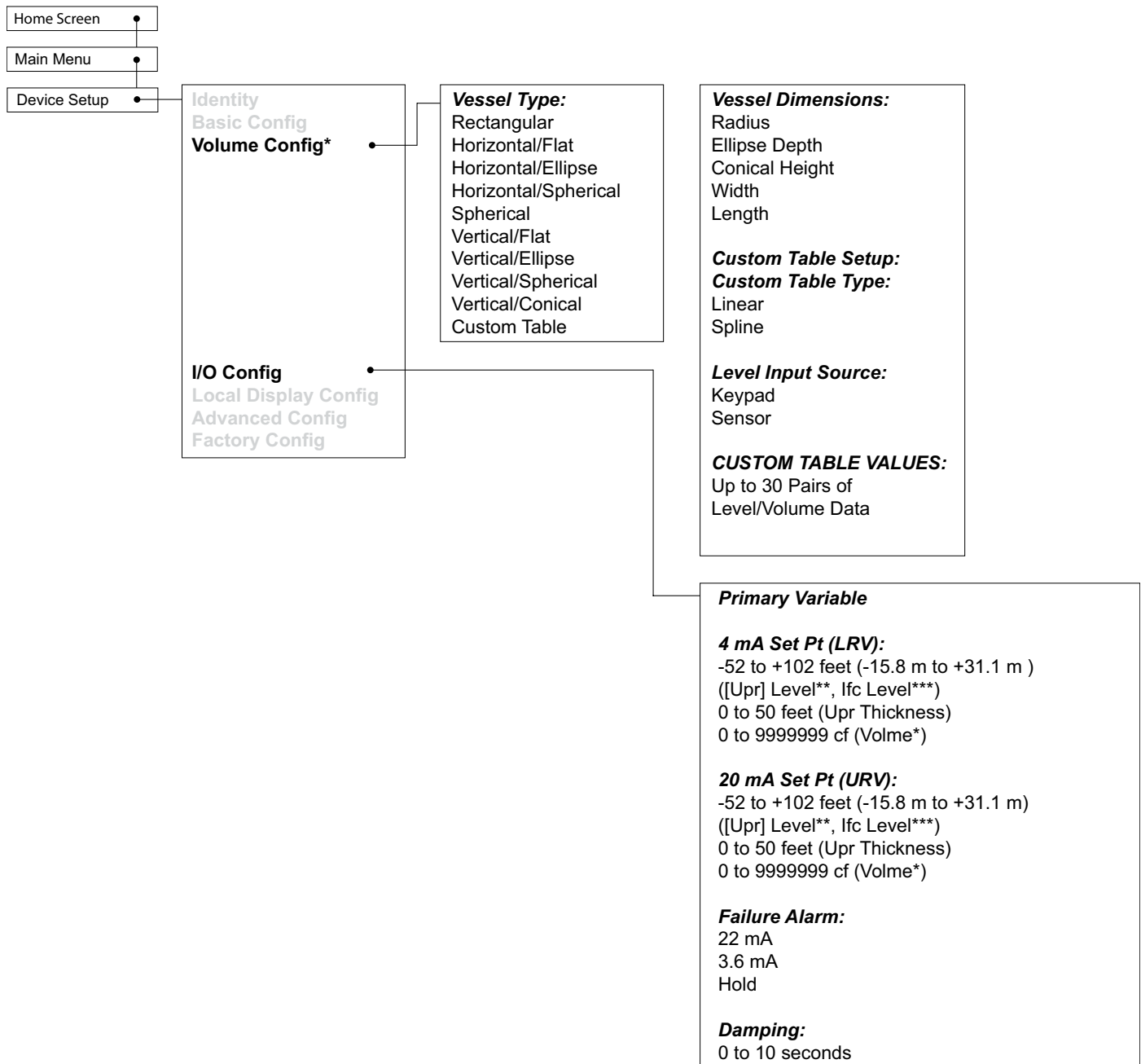

* Only available when Measurement Type = Volume & Level

** Not available when Measurement Type = Interface Only

*** Only available when Measurement Type = Interface Only or Interface & Level

**** Only Available when Measurement Type = Interface & Level

1.5.6 Model JM4 Configuration Menu – Device Setup

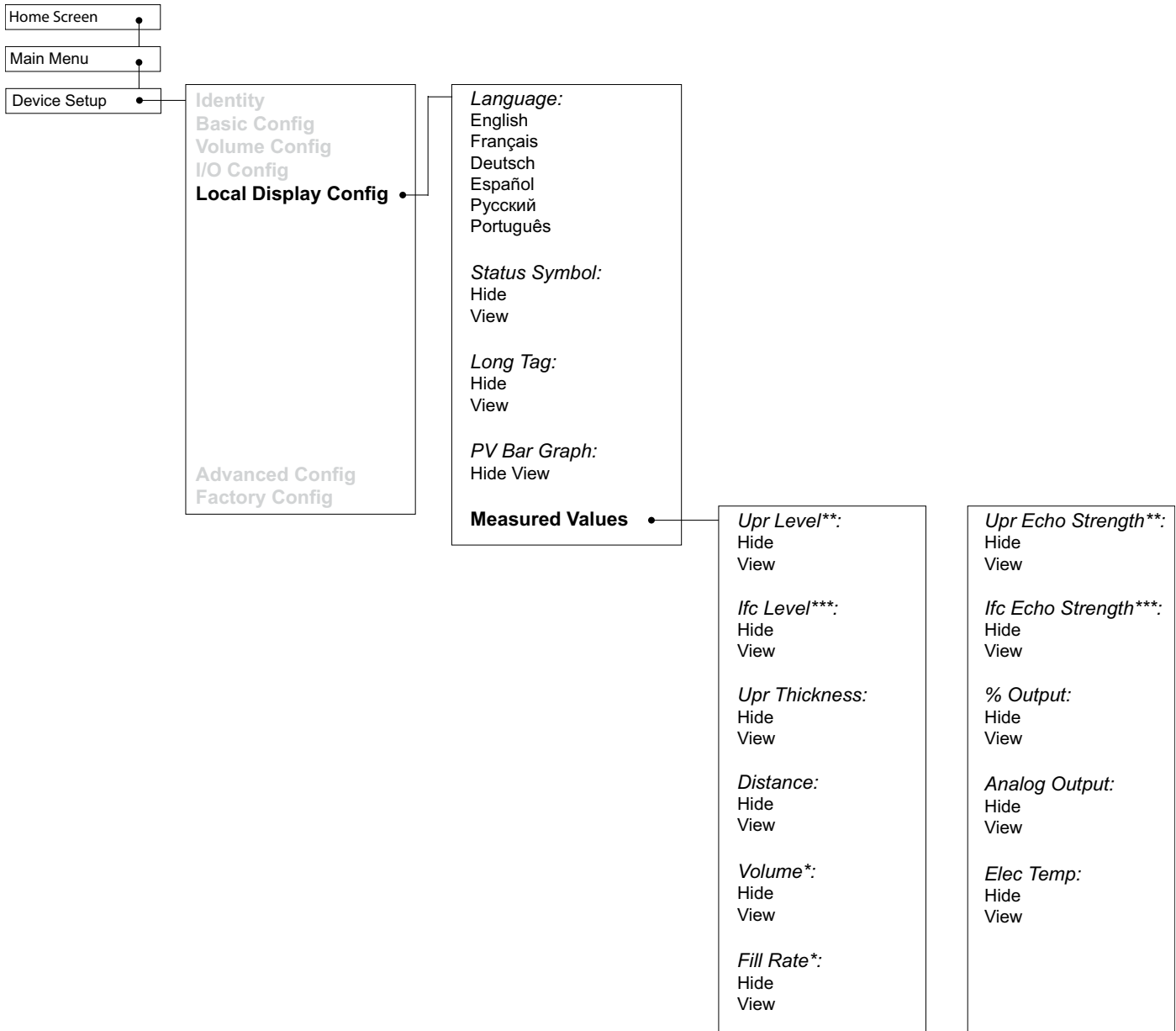

* Only available when Measurement Type = Volume & Level

** Not available when Measurement Type = Interface Only

*** Only available when Measurement Type = Interface Only or Interface & Level

**** Only Available when Measurement Type = Interface & Level

1.5.6 Model JM4 Configuration Menu – Device Setup

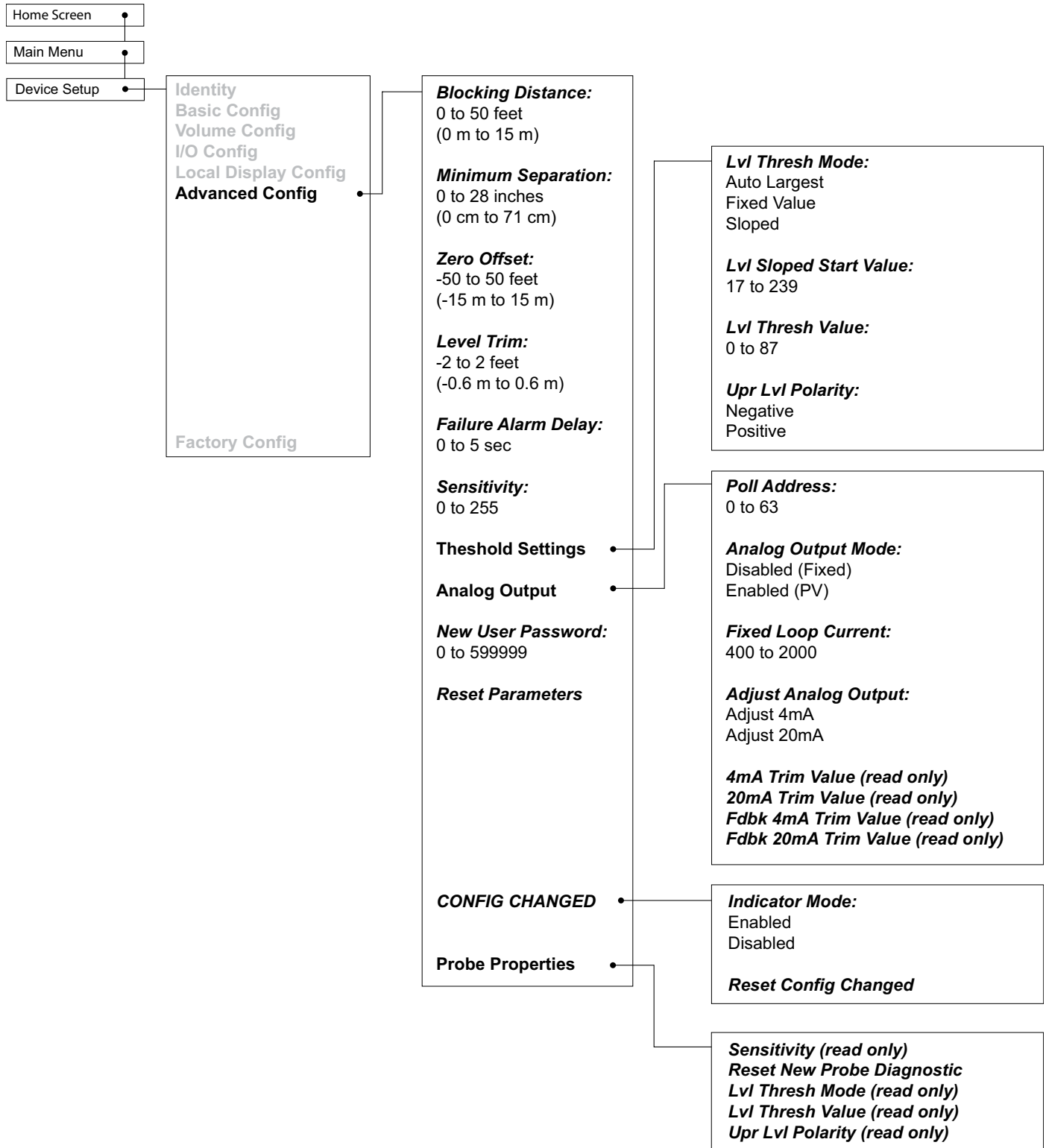

1.5.6 Model JM4 Configuration Menu – Device Setup

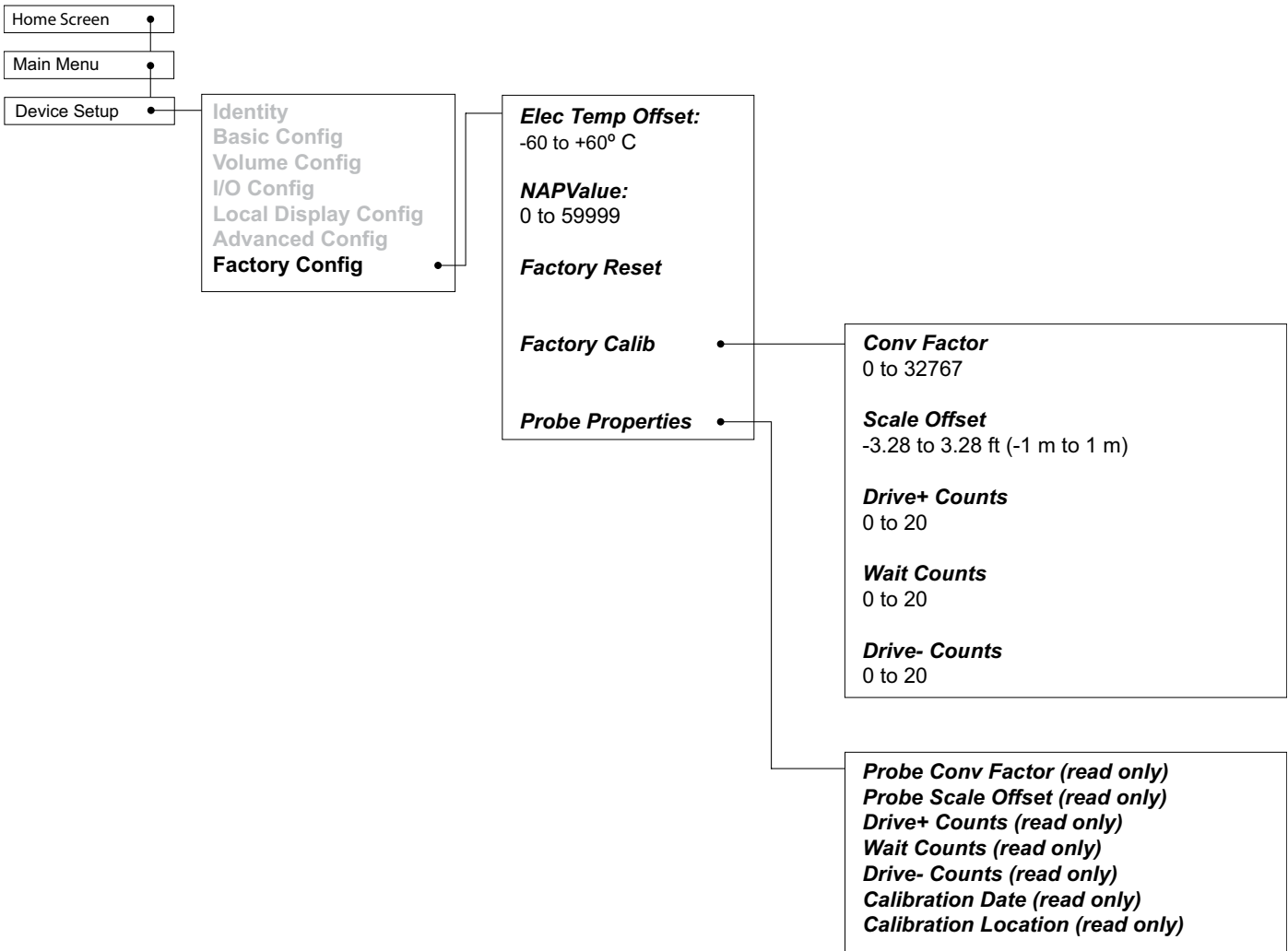

1.6 Configuration using HART

A HART (Highway Addressable Remote Transducer) remote unit, such as a HART communicator, can be used to provide a communication link to the Jupiter Model JM4 transmitter. When connected to the control loop, the same system measurement readings shown on the transmitter are also shown on the communicator. The communicator can also be used to configure the transmitter. The HART communicator may need to be updated to include the Jupiter Model JM4 software (Device Descriptions). Refer to your HART Communicator Manual for update instructions.

1.6.1 Connections

A HART communicator can be operated from a remote location by connecting it to a remote junction or by connecting it directly to the terminal block in the wiring compartment of the Jupiter transmitter.

HART uses the Bell 202 frequency shift keying technique of high-frequency digital signals. It operates on the 4–20 mA loop and requires 250 Ω load resistance. A typical connection between a communicator and the Jupiter transmitter is shown in Figure 1-10.

1.6.2 HART Communicator Display

A typical communicator display is an 8-line by 21-character LCD. When connected, the top line of each menu displays the model (Model JM4) and its tag number or address. For detailed operating information, refer to the instruction manual provided with the HART communicator.

1.6.3 HART Revision Table

Model JM4 1.x

HART Version	HCF Release Date	Compatible with JM4 Software
Dev Rev 1, DD Rev 1	May 2014	Version 1.0 and later

1.6.4 HART Menu – Model JM4

The Jupiter transmitter HART menu trees are shown in the following pages. Open the menu by pressing the alphanumeric key 4, then Device Setup, to display the second-level menu.

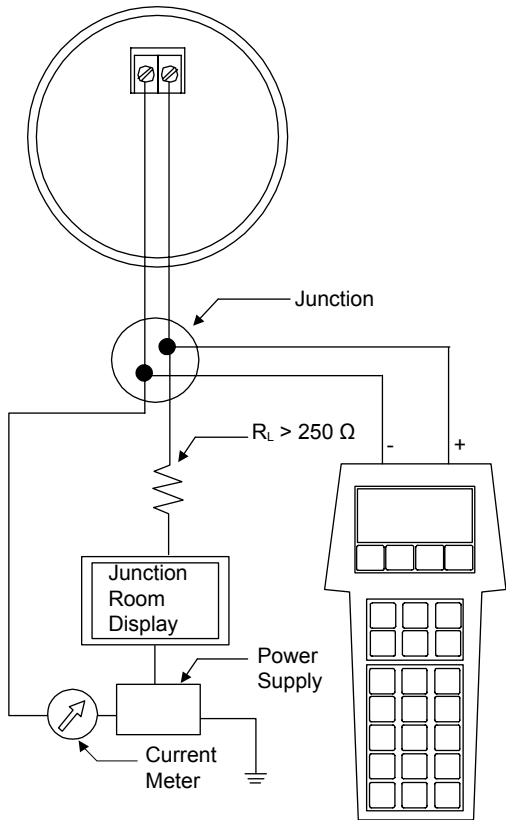
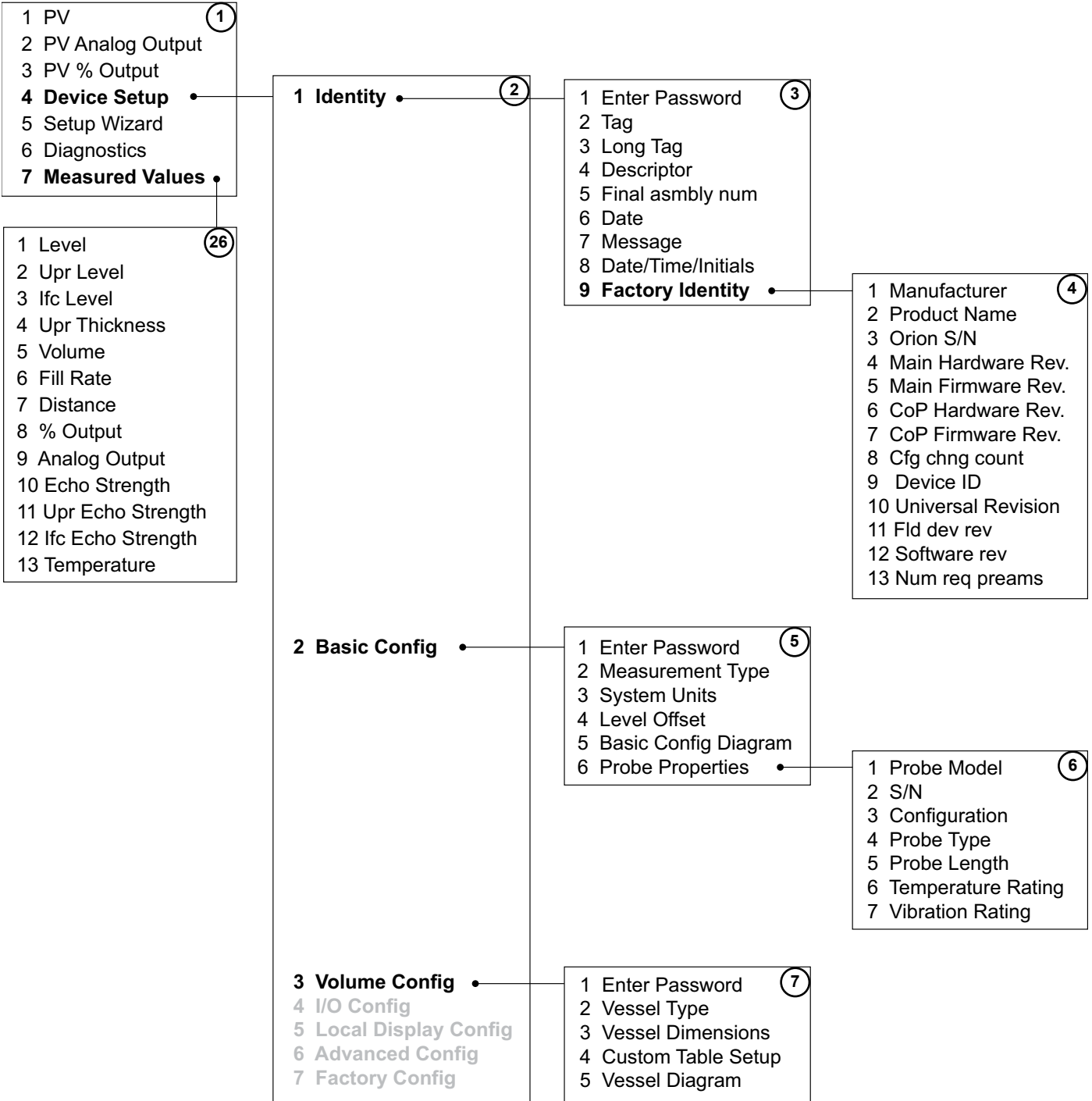

Fig. 1-12. Placement of Portable HART Communicator in Communication Loop

1.6.4 HART Menu – Model JM4

NOTE: Numbered menu boxes below correspond to numbered tables on Section 1.6.5.



1.6.4 HART Menu – Model JM4

NOTE: Numbered menu boxes below correspond to numbered tables on Section 1.6.5.

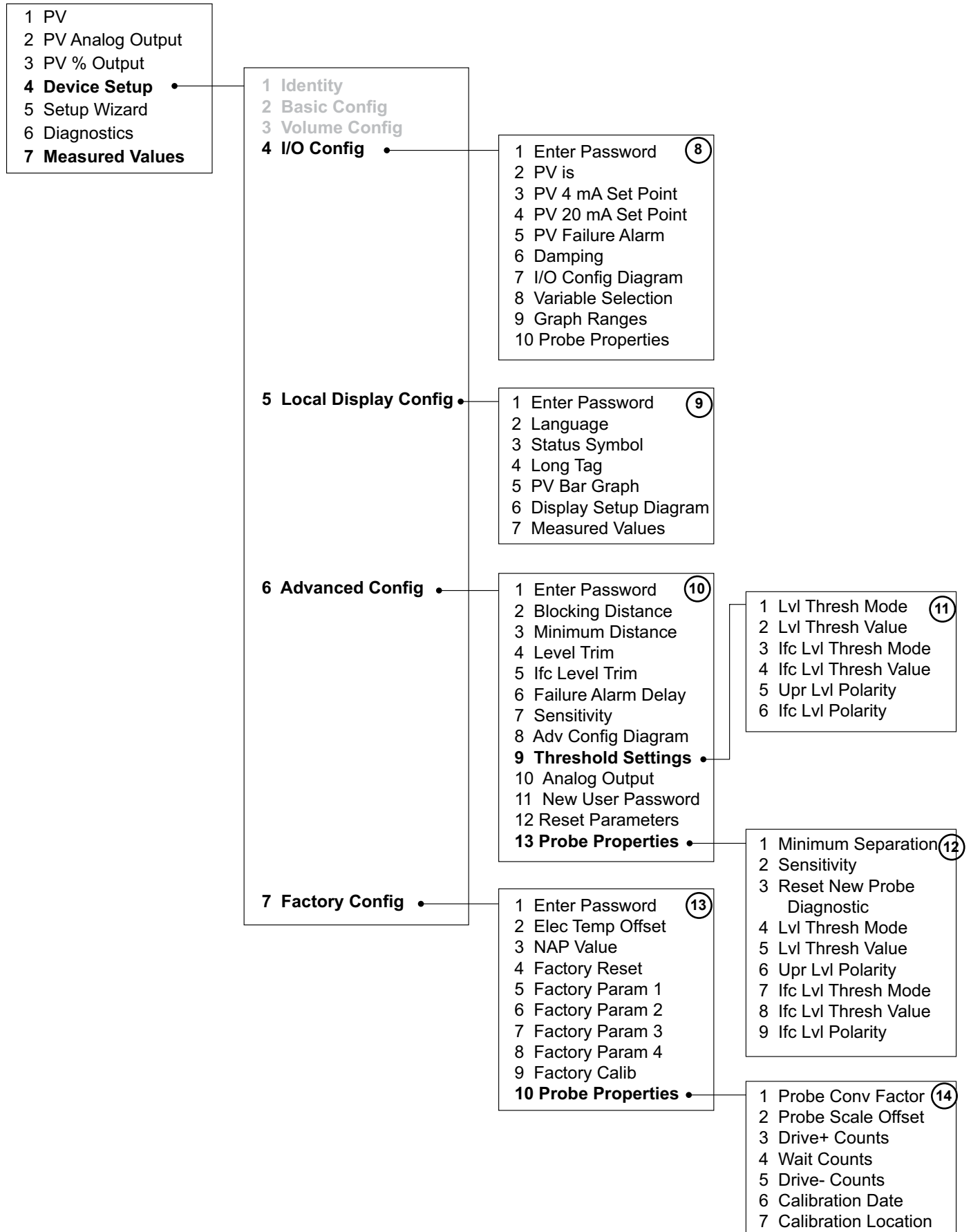

1.6.4 HART Menu – Model JM4

NOTE: Numbered menu boxes below correspond to numbered tables on Section 1.6.5.

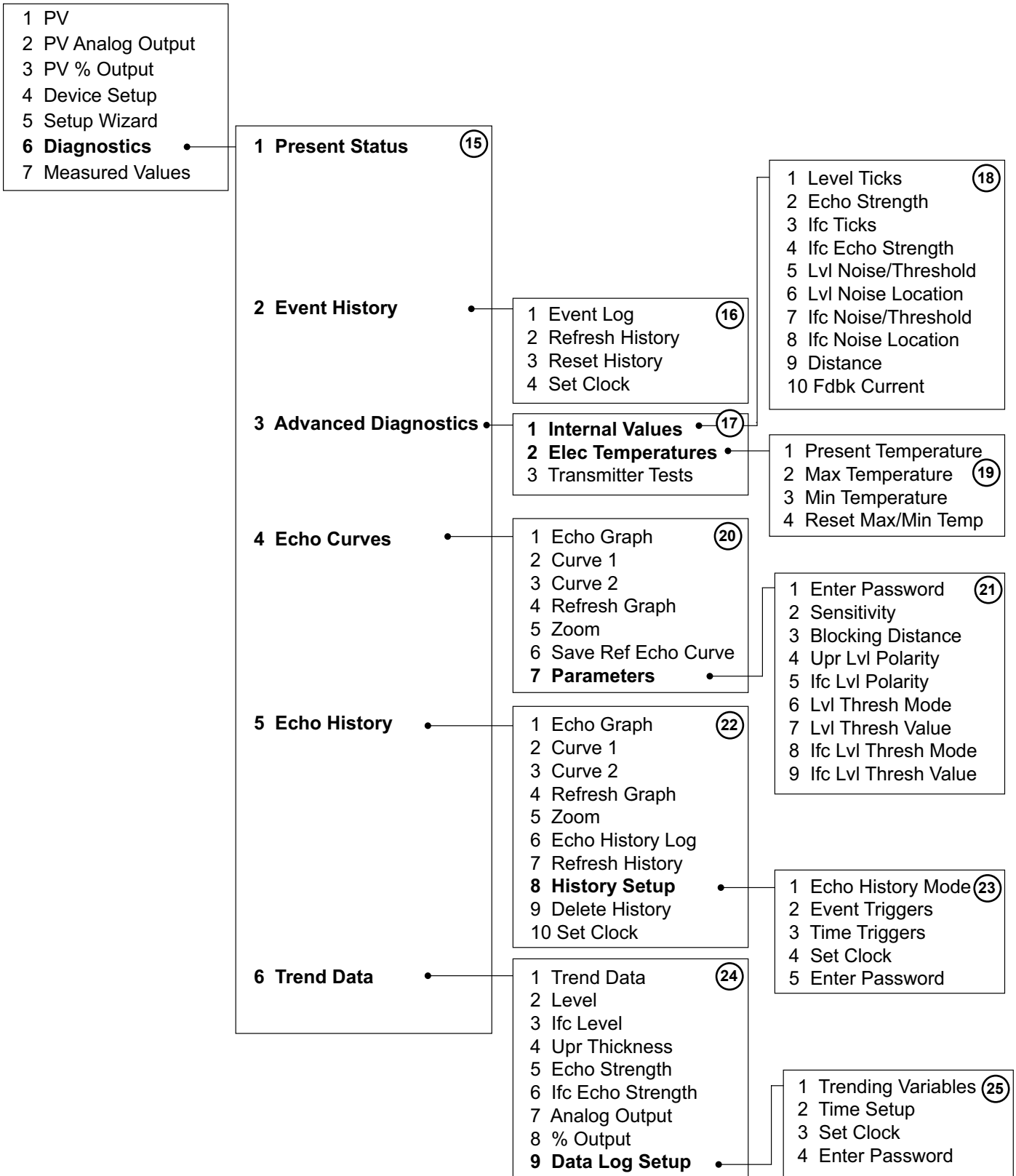

1.6.5 HART Menu Items

①

	Display	Description
1	PV	Digital representation that tracks the Analog Output Number 1, under normal operating modes. Level of material on the probe. (When in interface mode, this value corresponds to the level of the upper surface.)
2	PV Analog Output	Digital representation that tracks the Analog Output Number 1, under normal operating modes. Analog Output Value: Value that tracks the Digital Value representation, under normal operating modes
3	PV % Output	Digital representation that tracks the Analog Output Number 1, under normal operating modes. Analog Output Value: Value that tracks the Digital Value representation, under normal operating modes
4	Device Setup	Set of menus to allow full configuration of the transmitter.
5	Setup Wizard	
6	Diagnostics	Menu showing Diagnostic information.
7	Measured Values	A read-only screen that presents the various output values that can be displayed. (Available options will depend on Measurement Type.)

②

	Display	Description
1	Identity	A read-only screen that displays basic manufacturer's information about the transmitter.
2	Basic Config	A menu that allows for basic configuration of the transmitter.
3	Volume Config	A menu that allows for entry of known tank shapes or custom tables for volumetric output. This menu contains various tank shapes for easy configuration for those applications requiring Volumetric output.
4	I/O Config	Allows for configuration of the 4/20mA Analog Output, which includes the lower and upper set points, Damping, and Failure Alarms.
5	Local Display Config	Allows for customized presentation of information on the graphic LCD. The LCD can be configured to display up to two Measured Variables, along with a Tag, Bar Graph, and NE 107 symbols.
6	Advanced Config	Allows for more advanced configuration and troubleshooting. (Advanced Password may be required for access to parameters.) Contact Technical Support.
7	Factory Config	Allows viewing of Factory Parameters. These parameters are protected by a factory password and are not intended to be adjusted in the field.

* For 'Volume & Level' Measurement Type only.

1.6.5 HART Menu Items (cont.)

③

	Display	Description
1	Enter Password	
2	Tag	Text that is associated with the Field Device installation. This text can be used by the user in any way. A recommended use is as a unique label to a plant that correlates to a Field Device label, a plant drawing, or on a Control System. This variable is also used as a type of data link layer address handle.
3	Long Tag	Functions exactly like Tag except the size is larger (maximum of 32 ISO Latin 1 characters).
4	Descriptor	Text that is associated with the Field Device. This text can be used by the user in any way. There is no specific recommended use.
5	Final asmbly num	Number that is used for identification purposes, and is associated with the overall Field Device.
6	Date	Gregorian calendar date that is stored in the Field Device. This date can be used by the user in any way. There is no specific recommended use.
7	Message	Text that is associated with the Field Device. This text can be used by the user in any way. There is no specific recommended use.
8	Date/Time/Initials	When and by whom calibration was performed.
9	Factory Identity	A read-only screen that displays detailed manufacturer's information about the transmitter, such as Serial Number and hardware/software revisions.

④

	Display	Description
1	Manufacturer	References a specific manufacturer, which is usually a company name, that is responsible for the manufacture of this Field Device.
2	Product Name	Transmitter Trade Name.
3	Orion S/N	Serial number of the electronics contained in this transmitter.
4	Main Hardware Rev.	This revision corresponds to the electronics that are used in the Field Device.
5	Main Firmware Rev.	This revision corresponds to the software or firmware that is embedded in the Main Processor of the Field Device.
6	CoP Hardware Rev.	This revision corresponds to the electronics that are used in the Field Device.
7	CoP Firmware Rev.	This revision corresponds to the software or firmware that is embedded in the CoProcessor of the Field Device.
8	Cfg chng coun	Indicates the number of times the device's configuration or calibration has been changed by a host application or from a local operator interface.
9	Device ID	Uniquely identifies the Field Device when combined with the Manufacturer Identification and Device Type. Therefore, this variable cannot be modified by the Host user.
10	Universal Revision	Revision of the Universal Device Description, to which the Field Device conforms.
11	Fld dev rev	Revision of the Field Device Specific Device Description, to which the Field Device conforms.
12	Software rev	This revision corresponds to the firmware that is embedded in the Field Device.
13	Num req pream	Number of Preambles required from the Host request by the Field Device.

1.6.5 HART Menu Items (cont.)

5

	Display	Description
1	Enter Password	
2	Measurement Type	The desired measurement mode of operation. (Selection of Measurement Type may be constrained by the Probe Model.)
3	System Units	A menu that allows for setting the measurement units used by the transmitter.
4	Level Offset	Desired level reading when liquid surface is at the tip of the probe. (Range is -50 feet [-15 meters] to +50 feet [15 meters])
5	Basic Config Diagram	
6	Probe Properties	Displays probe configuration parameters.

6

	Display	Description
1	Probe Model	Type of probe connected to the transmitter, as shown by the probe model number on the name-plate. Refer to the I/O Manual for additional information regarding different Probe Models.
2	S/N	Serial number of the probe connected to this transmitter.
3	Configuration	Probe configuration with sensor location.
4	Probe Type	Type of probe connected to the transmitter.
5	Probe Length	Distance from probe reference point to end of probe. Up to 35 feet (10.7 meters) maximum depending on Probe Model. (Probe reference point is bottom of NPT Threads, top of BSP Threads, or flange face for direct insertion, or end of probe head assembly for external mount.)
6	Temperature Rating	Temperature rating of the probe.
7	Vibration Rating	Vibration rating of the probe.

7

	Display	Description
1	Enter Password	
2	Vessel Type*	Shape of vessel. (Used when Measurement Type = Volume)
3	Radius*	Radius of the cylindrical/spherical portion of the vessel
	Length	Horizontal length of the rectangular vessel or of the cylindrical portion of a vessel with elliptical or spherical ends.
	Width	Horizontal width of the rectangular vessel.
4	Custom Table	Allows for Custom Volume Strapping Table entry.
5	Vessel Diagram	

1.6.5 HART Menu Items (cont.)

8

	Display	Description
1	Enter Password	
2	PV is	An index location that indicates which Field Device dynamic variable has been mapped into the Primary Variable dynamic variable.
3	PV 4 mA Set Point	Enter 4 mA point in level units
4	PV 20 mA Set Point	Enter 20 mA point in level units
5	PV Failure Alarm	Digital representation that tracks the Analog Output Number 1, under normal operating modes. Defines how the Analog Output will respond when the Field Device detects that the Analog Output may not be tracking the associated Field Device Variable. NOTE- The Digital Value representation may not be determinate.
6	Damping	A damping factor (0-10 seconds) may be added to smooth the output in the event of turbulence.
7	I/O Config Diagram	
8	Variable Selection	Allows for selection of the Secondary Variable (SV), Tertiary Variable (TV), and Quaternary Variable (QV). The analog 4/20 mA output will follow the PV.
9	Graph Ranges	Defines the limits of the vertical axes in DD/DTM graphs.
10	Probe Properties	
-	Lvl 4mA Set Point	Defines the operational endpoint from which the Analog Value and the 0% point of the Percent Range are derived. In addition, the Lower Range Value defines an operational endpoint from which the alarms associated with the Analog Value and the alarms associated with the Digital Value representation are derived.
-	Ifc 4mA Set Point*	
-	Thk 4mA Set Point*	
-	Vol 4mA Set Point**	
-	Lvl 20mA Set Point	Defines the operational endpoint from which the Analog Value and the 100% point of the Percent Range are derived. In addition, the Upper Range Value defines an operational endpoint from which the alarms associated with the Analog Value and the alarms associated with the Digital Value representation are derived.
-	Ifc 20mA Set Point*	
-	Thk 4mA Set Point*	
-	Vol 20mA Set Point**	

* For 'Interface & Level' Measurement Type Only

** For 'Volume & Level' Measurement Type only.

1.6.5 HART Menu Items (cont.)

9

	Display	Description
1	Enter Password	
2	Language	Enables choice of language to be displayed on the LCD.
3	Status Symbol	Enables NE 107 Status symbol to be displayed on Home Screen.
4	Long Tag	Enables Long Tag to be displayed on the Home Screen.
5	PV Bar Graph	Enables a bar graph (displaying the Primary Variable in percent) to be displayed on the Home Screen.
6	Display Setup Diagram	
7	Measured Values	A read-only screen that presents the various output values that can be displayed. (Available outputs will depend on Measurement Type).
-	Upr Level	A read-only screen that presents the various output values that can be displayed. (Available outputs will depend on Measurement Type).
-	Ifc Level	
-	Upr Thickness	
-	Distance	
-	Volume	
-	Fill Rate	
-	Upr Echo Strength	
-	Ifc Echo Strength	
-	% Output	
-	Analog Output	
-	Elec Temp	

1.6.5 HART Menu Items (cont.)

10

	Display	Description
1	Enter Password	
2	Blocking Distance	Distance below the reference point within which level is ignored. (Operation is undefined when the liquid level is within the blocking distance.)
3	Level Trim	An offset value to be used to force the transmitter to output the exact Level or Distance. This should only be used after all parameters have been entered correctly, and it has been confirmed that the transmitter is tracking the correct level.
4	Ifc Level Trim	
5	Failure Alarm Delay	Delay that can be added to loop failure condition. This delay can be used to ignore nuisance, short term alarms. Initial setting of this delay should be short, e.g., 1-2 seconds.
6	Sensitivity	Present Sensitivity (gain) of the instrument. Default setting depends on the value in the probe memory and is suitable for most installations. Refer to I & O manual before adjusting.
7	Adv Config Diagram	
8	Threshold Settings	Allows for configuration of the various threshold settings. Automatic Threshold is used to detect the strongest signal on the probe and should only be used when it is ensured that only one medium is present. Fixed Threshold is used to detect the first valid signal on the probe and should be used in cases where stratification can occur. For example, applications where water bottoms can occur.
9	Analog Output	Certain parameters are password protected to limit access by the user. Parameters that should never be changed by the user are protected with the Factory password. Some parameters, intended for field use, that may be changed in special, controlled situations require the Advanced password.
10	New User Password	Change password that is required to access user parameters.
11	Reset Parameters	Reset the device to factory calibrated settings. If using a HART host, disconnect and then reconnect the host after performing the reset.
12	Probe Properties	Displays probe configuration parameters.

11

	Display	Description
	Lvl Thresh Mode	Selects the signal threshold control for measuring the upper level pulse. Default setting depends on the value in the probe memory and is suitable for most installations. Refer to I & O manual before adjusting.
	Lvl Thresh Value	
	Ifc Lvl Thresh Mode	
	Ifc Lvl Thresh Value	
	Upr Lvl Polarity	Selects the polarity for measuring the upper level pulse. Typically set to match the polarity of the first portion of the sine-wave signal of a direct insertion float, or the first portion of the M-shaped signal of an external mount probe.
	Ifc Lvl Polarity	

1.6.5 HART Menu Items (cont.)

12

	Display	Description
1	Minimum Separation	Minimum distance that can be achieved between the magnets on adjacent floats when the floats are touching each other.
2	Sensitivity	Present Sensitivity (gain) of the instrument. Default setting depends on the value in the probe memory and is suitable for most installations. Refer to I & O manual before adjusting.
3	Reset New Probe Diagnostic	Clears the diagnostic that indicates a new probe has been attached. Updates the memory in the transmitter to match the probe.
4	Lvl Thresh Mode	Selects the signal threshold control for measuring the upper level pulse. Default setting depends on the value in the probe memory and is suitable for most installations. Refer to I & O manual before adjusting.
5	Lvl Thresh Value	
6	Upr Lvl Polarity	Selects the polarity for measuring the upper level pulse. Typically set to match the polarity of the first portion of the sine-wave signal of a direct insertion float, or the first portion of the M-shaped signal of an external mount probe.
7	Ifc Lvl Thresh Mode	Selects the signal threshold control for measuring the upper level pulse. Default setting depends on the value in the probe memory and is suitable for most installations. Refer to I & O manual before adjusting.
8	Ifc Lvl Thresh Value	
9	Ifc Lvl Polarity	Selects the polarity for measuring the upper level pulse. Typically set to match the polarity of the first portion of the sine-wave signal of a direct insertion float, or the first portion of the M-shaped signal of an external mount probe.

13

	Display	Description
1	Enter Password	
2	Elec Temp Offset	PCB temperature calibration value. Refer to I & O manual before adjusting.
3	NAP Value	Advanced Password used for advanced troubleshooting.
4	Factory Reset	Reset the device to factory default settings. If using a HART host, disconnect and then reconnect the host after performing the reset.
5	Factory Param 1	Factory parameter. Displayed for diagnostic purposes only.
6	Factory Param 2	
7	Factory Param 3	
8	Factory Param 4	
9	Factory Calib	Read-Only Menu showing Factory Calibration Parameters.
10	Probe Properties	Displays probe configuration parameters.

14

	Display	Description
1	Probe Conv Factor	Factory parameter. Displayed for diagnostic purposes only.
2	Probe Scale Offset	
3	Drive+ Counts	
4	Wait Counts	
5	Drive- Counts	
6	Calibration Date	Date on which the probe was calibrated.
7	Calibration Location	Location where the probe was calibrated.

1.6.5 HART Menu Items (cont.)

15

	Display	Description
1	Present Status	Shows the Present Status (health) of the transmitter.
2	Event History	The history of the 10 most recent diagnostic events.
3	Advanced Diagnostics	Menu containing Advanced Diagnostic parameters.
4	Echo Curves	Allows configuration of the Echo Curve option.
5	Echo History	Allows configuration of the Echo History Option. Saving an Echo Curve under a fault condition is important for accurate troubleshooting.
6	Trend Data	Graph displaying real-time trend data.

16

	Display	Description
1	Event Log	Allows for viewing of the 10 most recent diagnostic indicators.
2	Refresh History	Displays a history of most recent diagnostic events. For each event, the time when the event occurred and the duration of the event are shown. The table of history events displays the most recent event at the top with successively preceding events in descending order.
3	Reset History	Clears entries in Status History and resets the run time to zero.
4	Set Clock	Sets the Real-Time Clock in the device.

17

	Display	Description
1	Internal Values	Shows detailed transmitter performance-related parameters.
2	Elec Temperatures	This menu displays the Maximum, Minimum, and Present temperatures of the electronics.
3	Transmitters Tests	Menu containing various tests to determine the functioning of the device.

18

	Display	Description
1	Level Ticks	Relative location of level signal. Displayed for diagnostic purposes only.
2	Echo Strength	Relative amplitude of the level signal. Displayed for diagnostic purposes only.
3	Ifc Ticks	Relative location of the interface level signal. Displayed for diagnostic purposes only.
4	Ifc Echo Strength	Relative amplitude of the interface level signal. Displayed for diagnostic purposes only.
5	Lvl Noise/Threshold	Amplitude of the largest noise signal in percent of the level threshold.
6	Lvl Noise Location	Location on the probe where greatest upper level noise has occurred. Location is relative to the lower probe end.
7	Ifc Noise/Threshold	Amplitude of the largest noise signal in percent of the interface threshold.
8	Ifc Noise Location	Location on the probe where greatest interface level noise has occurred. Location is relative to the lower probe end.
9	Distance	Distance from the sensor reference point to the upper surface level.
10	Fdbk Current	Factory parameter. Displayed for diagnostic purposes only.

1.6.5 HART Menu Items (cont.)

19

	Display	Description
1	Present Temperature	Present temperature measured in the electronics compartment.
2	Max Temperature	Maximum temperature measured in the electronics compartment.
3	Min Temperature	Minimum temperature measured in the electronics compartment.
4	Reset Max Min Temp	Reset the maximum and minimum temperatures measured in the electronics compartment to the present temperature.

20

	Display	Description
1	Echo Graph	
2	Curve 1	Select the primary curve to display.
3	Curve 2	Select the secondary curve to display.
4	Refresh Graph	Click to refresh Echo Curve.
5	Zoom	Allows user to zoom in and out of a specific portion of the Echo Curve.
6	Save Ref Echo Curve	Method to save a reference echo curve in the device. The reference echo curve will be retained until over-written by a new reference echo curve.
7	Parameters	

21

	Display	Description
1	Enter Password	
2	Sensitivity	Present Sensitivity (gain) of the instrument. Default setting depends on the value in the probe memory and is suitable for most installations. Refer to I & O manual before adjusting.
3	Blocking Distance	Distance below the reference point within which level is ignored. (Operation is undefined when the liquid level is within the blocking distance.)
4	Upr Lvl Polarity	Selects the polarity for measuring the upper level pulse. Typically set to match the polarity of the first portion of the sine-wave signal of a direct insertion float, or the first portion of the M-shaped signal of an external mount probe.
5	Ifc Lvl Polarity	Selects the polarity for measuring the interface level pulse. Typically set to match the polarity of the first portion of the sine-wave signal of a direct insertion float, or the first portion of the M-shaped signal of an external mount probe.
6	Lvl Thresh Mode	Selects the signal threshold control for measuring the upper level pulse. Default setting depends on the value in the probe memory and is suitable for most installations. Refer to I & O manual before adjusting.
7	Lvl Thresh Value	Relative setting of the threshold for detecting level. Default setting depends on the value in the probe memory and is suitable for most installations. Refer to I & O manual before adjusting.
8	Ifc Lvl Thresh Mode	Selects signal threshold control for measuring liquid-liquid interface level. Default setting depends on the value in the probe memory and is suitable for most installations. Refer to I & O manual before adjusting.
9	If Lvl Thresh Value	Relative setting of the threshold for detecting interface level. Default setting depends on the value in the probe memory and is suitable for most installations. Refer to I & O manual before adjusting.

1.6.5 HART Menu Items (cont.)

22

	Display	Description
1	Echo Graph	
2	Curve 1	Select the primary curve to display.
3	Curve 2	Select the secondary curve to display.
4	Refresh Graph	Click to refresh Echo Curve.
5	Zoom	Allows user to zoom in and out of a specific portion of the Echo Curve.
6	Echo History Log	Listing of echo curves saved in the device.
7	Refresh History	Method to re-read the echo history summary.
8	History Setup	Menu for setting up the automatic echo history capture feature of the device.
9	Delete History	Allows the History information to be cleared and reset.
10	Set Clock	Sets the Real-Time Clock in the device.

23

	Display	Description
1	Echo History Mode	Selection to save echo curves based on time intervals or selected diagnostic events.
2	Event Triggers	Listing of diagnostic indicators that can be selected to trigger an automatic saving of an echo curve.
3	Time Triggers	Listing of parameters to control time-based automatic saving of echo curves.
4	Set Clock	Sets the Real-Time Clock in the device.
5	Enter Password	

24

	Display	Description
1	Trend Data	Graph displaying real-time trend data.
2	Level	Level of material on the probe. (When in interface mode, this value corresponds to the level of the upper surface.)
3	Ifc Level	Level of liquid-liquid interface. (When no interface is present, this value corresponds to the level of product in the vessel.)
4	Upr Thickness	Thickness of the upper liquid layer.
5	Echo Strength	Relative strength of the level signal being detected. (When in the interface mode, this value corresponds to the strength of the upper level signal.)
6	Ifc Echo Strength	Relative strength of the interface level signal.
7	Analog Output	Allows for configuration of the 4/20mA Analog Output, which includes the Poll Address, Analog Output Mode, and trimming of the loop.
8	% Output	Percent of Output of the Primary Variable and Analog Output 1 Current.
9	Data Log Setup	Menu containing parameters to set up the device's internal data log feature.

1.6.5 HART Menu Items (cont.)

25

	Display	Description
1	Trending Variables	Listing of Device Variables that can be selected to be saved in the internal data log feature of the device.
2	Time Setup	A menu that allows the user to set the time span and sample interval for the Data Log.
3	Set Clock	Sets the Real-Time Clock in the device.
4	Enter Password	

26

	Display	Description
1	Level	Level of material on the probe. (When in interface mode, this value corresponds to the level of the upper surface.)
2	Upr Level	
3	Ifc Level	Level of liquid-liquid interface. (When no interface is present, this value corresponds to the level of product in the vessel.)
4	Upr Thickness	Thickness of the upper liquid layer.
5	Volume	Volume of product in the vessel.
6	Fill Rate	Fill rate of the liquid in the vessel.
7	Distance	Distance from the sensor reference point to the upper surface level.
8	% Output	Percent of Output of the Primary Variable and Analog Output 1 Current.
9	Analog Output	Value that tracks the Digital Value representation, under normal operating modes
10	Echo Strength	Relative strength of the level signal being detected. (When in the interface mode, this value corresponds to the strength of the upper level signal.)
11	Upr Echo Strength	
12	Ifc Echo Strength	Relative strength of the interface level signal.
13	Temperature	The present temperature of the electronics.

2.0 Reference Information

This section presents an overview of the operation of the Jupiter magnetostrictive transmitter, information on troubleshooting common problems, listing of agency approvals, lists of replacement and recommended spare parts, and detailed functional, performance and physical specifications for the instrument.

2.1 Description

The Jupiter is a two-wire, 24 VDC level transmitter based on the concept of magnetostrictive level measurement technology.

The Jupiter electronics are housed in an ergonomic housing of two tandem compartments angled at a 45° angle for ease of wiring and configuration.

2.2 Theory of Operation

Magnetostrictive level sensors are based on “time-of-flight” technology.

Permanent magnets contained within a float device tracks the process liquid as it changes level. The Jupiter probe is fixed within close proximity to this magnetic field. A short current pulse is then applied to a specially designed wire alloy contained within the probe. The interaction of the current pulse and magnetic field causes distortion in a small section of the wire alloy. This in turn creates a vibratory disturbance which begins to travel through the wire at a very constant rate of speed. The disturbance is later detected via a sensing device at the transmitter end of the probe and sent to the electronics unit where it is filtered and amplified.

Extremely accurate level measurement can thus be obtained precisely measuring the elapsed time between the current pulse (start), and the returned pulse (stop). The Jupiter electronics module processes these signals, and then performs various mathematical operations in order to provide the user with an analog and/or digital representation of the liquid level.

2.3 Troubleshooting

The JUPITER Model JM4 transmitter is designed and engineered for trouble-free operation over a wide range of operating conditions. The transmitter continuously runs a series of internal self-tests and displays helpful messages on the large graphic liquid crystal display (LCD) when attention is required.

The combination of these internal tests and diagnostics messages offer a valuable proactive method of troubleshooting. The device not only tells the user what wrong, but also, and more importantly, offers suggestions on how to solve the problem.

All of this information can be obtained directly from the transmitter on the LCD, or remotely by using a HART communicator or PACTware and the JUPITER Model JM4 DTM.

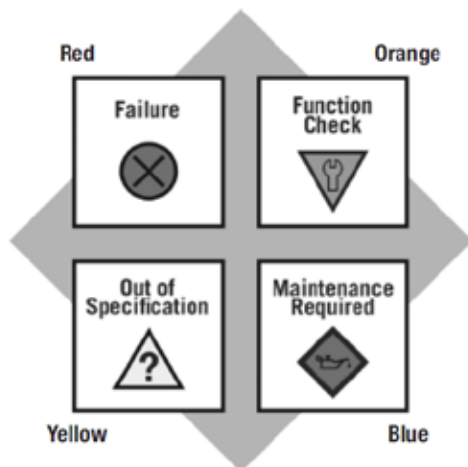

Fig. 2-1. Namur NE 107 Status Signals - Symbols

PACTware™ PC Program

The JUPITER Model JM4 offers the ability to perform more advanced diagnostics such as Trending and Echo Curve analysis using a PACTware DTM. This is a powerful troubleshooting tool that can aid in the resolution of any diagnostic indicators that may appear.

2.3.1 Diagnostics (Namur NE 107)

The JUPITER Model JM4 transmitter includes an exhaustive list of Diagnostic Indicators which follow the NAMUR NE 107 guidelines.

NAMUR is an international user association of automation technology in process industries, whose goal is to promote the interest of the process industry by pooling experiences among its member companies. In doing so, this group promotes international standards for devices, systems, and technologies.

The objective of NAMUR NE 107 was essentially to make maintenance more efficient by standardizing diagnostics information from field devices. This was initially integrated via FOUNDATION fieldbus, but the concept applies regardless of the communication protocol.

According to the NAMUR NE107 recommendation, “Self Monitoring and Diagnosis of Field Devices,” fieldbus diagnostic results should be reliable and viewed in the context of a given application. The document recommends categorizing internal diagnostics into four standard status signals:

- Failure
- Function Check
- Out of Specification
- Maintenance required

These categories are shown by both symbols and colors, depending on the display capability.

In essence, this approach ensures that the right diagnostic information is available to the right person-at the right time. In addition, it allows diagnostics to be applied, as most appropriate, for a particular plant application (such as process control engineering or asset management maintenance). Customer specific mapping of diagnostics to these categories allows for flexible configuration depending on the user’s requirements.

From an external Model JM4 transmitter perspective, diagnostic information includes measurement of process conditions, in addition to detection of internal device or system anomalies.

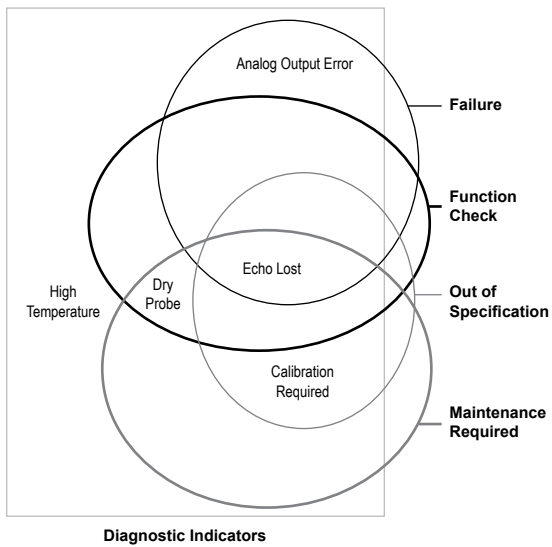

Fig. 2-2
 Namur NE 107 Status Signals - Venn Diagram

As mentioned above, the indicators can be assignable (via the a DTM or host system) by the user to any (or none) of the NAMUR recommended Status Signal categories: Failure, Function Check, Out of Specification, and Maintenance Required.

The FOUNDATION fieldbus transmitter version of the Model JM4 was implemented according to the Field Diagnostics Profile, which is consistent with the objectives of NE 107.

In the FOUNDATION fieldbus version, diagnostic indicators can be mapped to multiple categories, an example is shown in the diagram at left.

In this example, “Calibration Required” is mapped to both the Out of Specification and Maintenance Required status signals, and the diagnostic indicator named “High Temperature” is mapped to none of the signals.

Indicators that are mapped to the Failure category will normally result in a current loop alarm output. The alarm state for HART transmitters is configurable as high (22 mA), Low (3.6 mA), or Hold (last value).

Users will not have the ability to unassign certain indicators from the Failure signal category as the Model JM4 user interfaces will prohibit or reject such re-assignment entries). This is to ensure that current loop alarms are asserted in situations where the device is not able to provide measurements due to critical failures. (For example, if the alarm selection has not been set to Hold, or a fixed current mode is in effect.)

A default mapping of all diagnostic indicators will be applied initially, and can be re-applied through use of a reset function.

Refer to the table below for a complete listing of the Model JM4 diagnostic indicators, along with their explanations, default categories, and recommended remedies.

NOTES: 1. The remedies shown in this table can also be seen on the transmitter LCD by viewing the present status screen when the device is in a diagnostic condition.

2. Those indicators showing failure as the default result in an alarm condition.

2.3.2 Troubleshooting Table

Problem	Solution
Blank display	<p>Ensure local Keypad / LCD is properly installed. Remove power and reapply power to the unit.</p> <p>Check to see if LED on module is illuminated.</p> <p>Check voltage at terminal board.</p> <p>If jumper is in place under display, remove jumper.</p>
Transmitter does not track level	<p>(External Mount) Check echo curve for noise preventing tracking of level.</p> <p>(Direct Insertion) Remove transmitter and probe from piping column and test with re-alignment magnet. Run magnet from bottom to top of probe.</p> <p>Check zero and span calibration. If no change in output, consult the factory.</p>
Float inside the level gauge is moving slowly or not at all.	<p>Ensure that the magnetic level indicator is plumb.</p> <p>The process fluid being measured may be too viscous and heat tracing may be required to make the material more fluid.</p> <p>The specific gravity of the process fluid and float weight may need to be reverified.</p> <p>The liquid being measured may contain magnetic particles collecting on the magnetic section of the float causing drag. If this happens magnetic trap assemblies can be purchased from the factory.</p> <p>Visual inspection of the float may be required to see if the float has collapsed.</p>
LEVEL, % OUTPUT, and LOOP values are all inaccurate.	<p>Wipe probe with external magnet.</p> <p>Confirm configuration settings.</p> <p>Consult factory.</p>
LEVEL, % OUTPUT, and LOOP values fluctuate.	<p>Check echo curve for noise levels that could be affecting level reading.</p> <p>Turbulence, increase damping factor until readings stabilize.</p>
Level reading on display is correct, but loop value is stuck at 4 mA.	Set poll address to zero.

2.3.3 Status Messages

Display Message	Brief Description	Solution
No Probe	No probe connected to transmitter	Check probe connection to transmitter, Consult Factory
New Probe	Probe memory contents disagree with EEPROM image	On Display, go to 'Reset New Probe' and enter password.
Analog Board Error	No response from co-processor, or clock error	Consult Factory.
Probe Memory Error	Memory device in probe is unresponsive	Consult Factory.
No Float Detected	Echo curve does not rise above threshold	Run echo curve. If a visible peak exists, increase gain/sensitivity. If there is no peak, visually inspect probe to confirm presence of float. If float still not detected, consult factory.
Config Conflict	Measurement Type and Primary Variable selection parameters are inconsistent	Confirm measurement type matches PV. Good Examples: <ol style="list-style-type: none"> 1. MT = Level Only, PV = Total Level 2. MT = Level & IFC, PV = IFC
High Volume Alarm	Level exceeds highest level in strapping table or top of vessel by more than 5%	Confirm span set points are at desired values. Run echo curve. Check for noise at top of probe. If top mount or direct insertion unit, increase deadband/blocking distance
Extra Float Detected	Echo curve rises above threshold additional instance from expected number	Check Measurement type; Run echo curve to check for extra peaks; Decrease Gain/Sensitivity Settings; Swipe probe with pocket magnet to eliminate possibility of residual magnetism; Consult Factory.
2nd Float Missing	Echo curve rises above threshold only once	Check Measurement type; Run echo curve; Increase Gain/Sensitivity Settings; Verify two floats are present. Consult Factory.
High Elec Temp	Present electronics temperature above maximum	Take measures to cool transmitter head. Consider installing sunshade.
Low Elec Temp	Present electronics temperature below minimum	Take measure to warm transmitter head. Consider installing heat tracing.
Adjust Analog Out	Loop trim parameters are at default values	Perform Trim Loop Current Check via HART Communication
Low Supply Voltage	Power supply voltage inadequate to prevent brownout or reset	Check supply voltage.
Weak Upr Echo	Strength of echo from float at gas-liquid interface less than allowable minimum	Run echo curve. Increase Gain/Sensitivity Settings. Consult Factory.
Weak lfc Echo	Strength of echo from float at liquid-liquid interface less than allowable minimum	Run echo curve. Increase Gain/Sensitivity Settings; Consult Factory.
High Noise/Lvl Threshold	Strength of baseline noise too near upper level threshold	Check echo curve for noise levels. Echo Rejection may be required, Consult Factory, Swipe probe with pocket magnet to eliminate possibility of residual magnetism
High Noise/lfc Threshold	Strength of baseline noise too near interface level threshold	Check echo curve for noise levels. Echo Rejection may be required, Consult Factory, Swipe probe with pocket magnet to eliminate possibility of residual magnetism

2.3.4 Diagnostic Help

Selecting **DIAGNOSTICS** from the **MAIN MENU** presents a list of five **ITEMS** from the top level of the **DIAGNOSTICS** tree.

When **Present Status** is highlighted, the highest **MAGNETROL** priority active diagnostic indicator (numerically lowest in Table 3.3.3) is displayed on the bottom LCD line, which is “OK” as shown at left. Pressing the **ENTER** key moves the active diagnostic indicator to the top line outdented and presents in the lower area of the LCD a brief explanation of and possible remedies for the indicated condition. A blank line separates the explanation from the remedies. Additional active diagnostic indicators, if any, appear with their explanations in descending priority order. Each additional active indicator name-explanation pair is separated by a blank line from the one above.

If the explanation and remedy text (and additional name explanation pairs) exceeds the available space, a appears in the rightmost column of the last line indicating more text below. In this situation, the **DN** key scrolls text up one line at a time. Similarly, while text exists above the upper line of the text field, a appears in the rightmost column of the top (text) line. In this situation, the **UP** key scrolls the text down one line at a time. Otherwise the **DN** and **UP** keys are inoperative. In all cases the **ENT** or **DEL** key reverts to the previous screen.

When the transmitter is operating normally and the highlight cursor is positioned on **Present Status**, the bottom LCD line displays “OK” because no diagnostic indicators are active.

EVENT HISTORY – This menu displays the parameters related to diagnostic event logging.

ADVANCED DIAGNOSTICS – This menu displays parameters related to some of the advanced diagnostics available within the Model JM4.

INTERNAL VALUES – Displays read-only internal parameters.

ELEC TEMPERATURES – Displays temperature information as measured in the potted module in degrees F or C.

TRANSMITTER TESTS – Allows the user to manually set the output current to a constant value. This is a method for the user to verify operation of the other equipment in the loop.

ECHO CURVES – This menu allows the user to display the live Echo Curve and Echo Rejection on the LCD.



Fig. 2-3
Diagnostics Menu

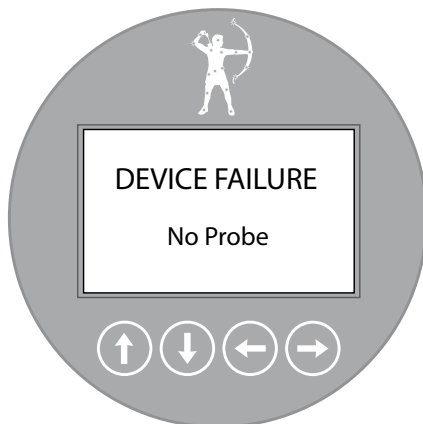

Fig. 2-4
Status Message - No Probe

2.4 Configuration Information

2.4.1 Volumetric Capability

Selecting Measurement Type = Volume and Level allows the Model JM4 transmitter to measure volume as the Primary Measured Value.

2.4.1.1 Configuration Using Built-In Vessel Types

The following table provides an explanation of each of the System Configuration parameters required for volume applications that use one of the nine Vessel Types.

Configuration Parameter	Explanation
Volume Units	A selection of Gallons (factory default Volume Unit), Milliliters, Liters, Cubic Feet, or Cubic Inches, is provided.
Vessel Type	Select either Vertical/Flat (factory default Vessel Type), Vertical/Elliptical, Vertical/Spherical, Vertical/Conical, Custom Table, Rectangular, Horizontal/Flat, Horizontal/Elliptical, Horizontal/Spherical, or Spherical. Note: Vessel Dims is the next screen only if a specific Vessel Type was selected. If Custom Table was selected. Refer to page 46 to select the Cust Table Type and Cust Table Vals.
Vessel Dims	See the vessel drawings on the following page for relevant measuring areas.
Radius	Used for all Vessel Types with the exception of Rectangular.
Ellipse Depth	Used for Horizontal and Vertical/Elliptical vessels.
Conical Height	Used for Vertical/Conical vessels.
Width	Used for Rectangular vessels.
Length	Used for Rectangular and Horizontal vessels.

Vessel Types

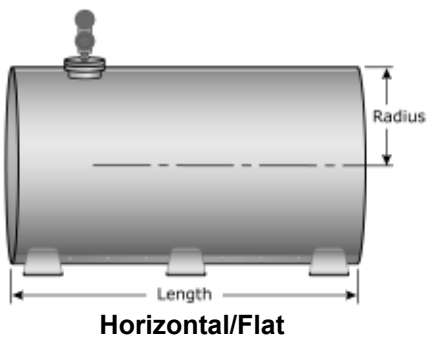
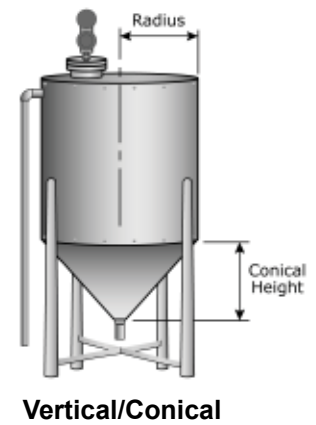
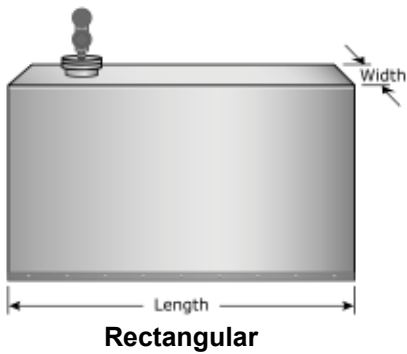
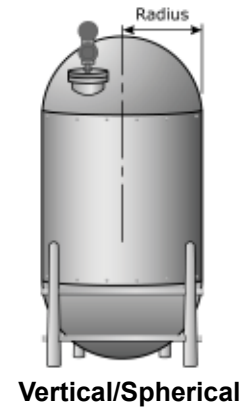
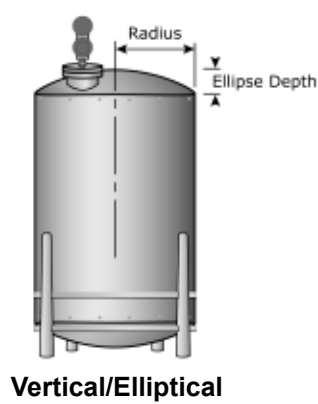
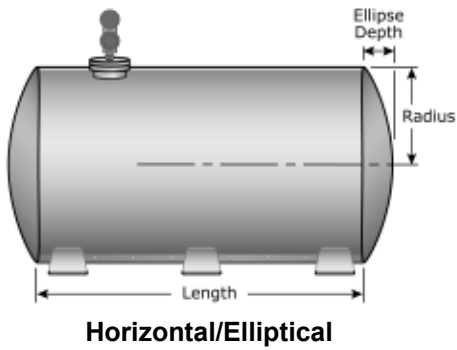
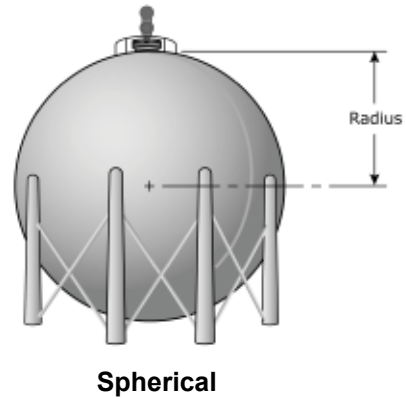
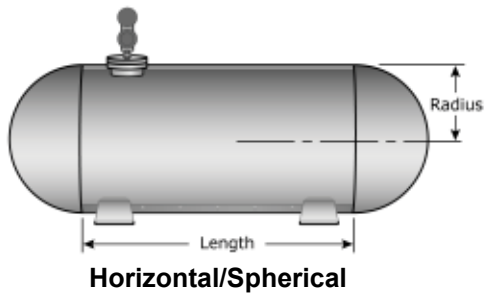

2.4.1.2 Configuration Using Custom Table

If none of the nine *Vessel Types* shown can be used, a *Custom Table* can be created. A maximum of 30 points can be used to establish the level to volume relationship. The following table provides an explanation of each of the System Configuration parameters for volume applications where a Custom Table is needed.

Configuration Parameter	Explanation (Custom Volumetric Table)
Volume Units	A selection of Gallons (factory default Volume Unit), Milliliters , Liters , Cubic Feet , or Cubic Inches , is provided.
Vessel Type	Select Custom Table if none of the nine <i>Vessel Types</i> can be used.
Cust Table Type	The <i>Custom Table</i> points can be a Linear (straight line between adjacent points) or Spline (can be a curved line between points) relationship. See below drawing for more information.
Cust Table Vals	A maximum of 30 points can be used in building the <i>Custom Table</i> . Each pair of values will have a level (height) in the units chosen in the <i>Level Units</i> screen, and the associated volume for that level point. The values must be monotonic, i.e. each pair of values must be greater than the previous level/volume pair. The last pair of values should have the highest level value and volume value associated with the level in the vessel.

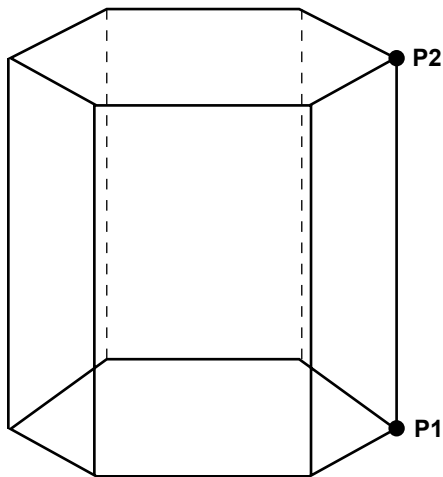

Linear

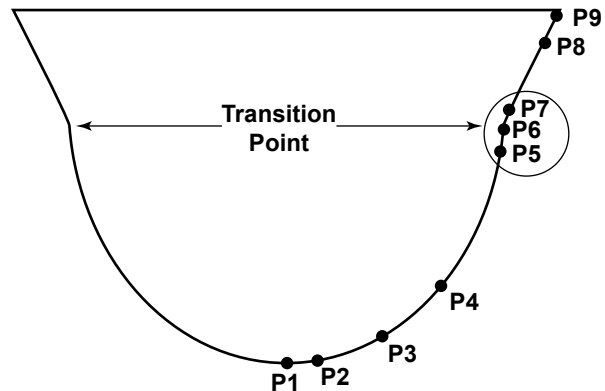

Use where walls are not perpendicular to base.

Concentrate at least two points at the beginning (P1) and end (P9); and three points at either side of transition points

SPLINE

2.4.2 Reset Function

A parameter labeled “Reset Parameter” is located at the end of the DEVICE SETUP/ADVANCED CONFIG menu. In the event a user gets confused during configuration or advanced troubleshooting, this parameter gives the user the ability to reset the Model JM4 transmitter configuration.

Unique to the Model JM4 transmitter is the ability for Orion Instruments to fully “pre-configure” devices to customer requests. For that reason, the Reset function will return the device back to the state at which it left the factory.

It is recommended that Orion Instruments Technical Support be contacted as the Advanced User password will be required for this reset.

2.4.3 Additional Diagnostic/Troubleshooting Capabilities

2.4.3.1 Event History

As a means for improved troubleshooting capability, a record of significant diagnostic events is stored with time and date stamps. A real time on board clock (which must be set by the operator), will maintain the current time.

2.4.3.2 Context-sensitive Help

Descriptive information relevant to the highlighted parameter in the menu will be accessible via the local display and remote host interfaces. This will most often be a parameter-related screen, but could also be information about menus, actions (for example, Loop [Analog Output] Test, resets of various types), diagnostic indicators, etc.

For example: Dielectric Range — Selects the range bounding the dielectric constant of the medium in vessel. For interface measurement mode, it selects the range bounding the dielectric constant of the lower liquid medium. Some ranges may not be selectable depending on the probe model.

2.4.3.3 Trend Data

Another new feature to the Model JM4 is the ability to log several measured values (selectable from any of the primary, secondary, or supplemental measured values) at a configurable rate (for example, once every five minutes) for a period ranging from several hours to a number of days (depending on the configured sample rate and number of values to be recorded). The data will be stored in nonvolatile memory in the transmitter with date and time information for subsequent retrieval and visualization using the associated Model JM4 DTM.

2.5 Agency Approvals



These units are in compliance with the EMC directive 2004/108/EC, the PED directive 97/23/EC and the ATEX directive 2014/34/EU.

<p><u>Explosion Proof</u> US/Canada: FM16US0357X/FM16CA0168X Class I, Div 1, Group B, C and D, T4 Ta = -40°C to +70°C Type 4X, IP67</p> <p><u>Flame Proof:</u> Flameproof US/ Canada: Class I, Zone 0/1, AEx db IIB + H2 T1...T6 Ga/Gb (US) Class I, Zone 0/1, Ex db IIB + H2 T1...T6 Ga/GB (Canada) Ta = -40 C to +70 C IP 67</p> <p>ATEX FM14ATEX0059X: II 1/2G Ex db IIB+H2 T6...T1 Ga/Gb Ta=-40°C to +70°C IP67</p> <p>IEC- IEC Ex FMG14.0028X Ex db IIB+H2 T6...T1 Ga/Gb Ta=-40°C to +70°C IP67</p>	<p><u>Non- Incendive</u> US/Canada: FM16US0357X/FM16CA0168X U.S. - Class I, II, III, Division 2, Group A, B, C, D, E, F, G, T4, Ta = -40°C to 70°C CANADA – Class I, Division 2, Group A,B,C,D T4, Ta = -40°C to 70°C Class I, Zone 2 AEx nA IIC T4 Gc Ta = -15°C to 70°C Class I, Zone 2 Ex nA IIC T4 Gc Ta = -15°C to +70°C Type 4X, IP67</p> <p>ATEX FM14ATEX0060X: II 3 G Ex nA IIC T4 Gc Ta = -15°C to +70°C IP67</p> <p>IEC – IECEx FMG 14.00028X: Ex nA IIC T4 Gc Ta = -15°C to + 70°C IP67</p>
<p><u>Intrinsically Safe</u> US/Canada: FM16US0357X/FM16CA0168X Class I, II, III, Div 1, Group A, B, C, D, E, F, G, T4, Class I, Zone 0 AEx ia IIC T4 Ga Class I, Zone 0 Ex ia IIC T4 Ga Ta = -40°C to + 70°C Type 4X, IP67</p> <p>ATEX – FM14ATEX0059X: II 1 G Ex ia IIC T4 Ga Ta = -40°C to +70°C IP67</p> <p>IEC – IECEx FMG 14.0028X: Ex ia IIC T4 Ga Ta = -40°C to +70°C IP67</p>	<p><u>Dust Ignition Proof</u> US/Canada: FM16US0357X/FM16CA0168X Class II, III, Division 1, Group E, F and G, T4 Ta = 5°C to +70°C Type 4X, IP67 US/Canada Zone Ratings as follows: Zone 21, AEx tb IIIC T86C...T120C Ta= -15 C to +70 C Db (US) Zone 21, Ex tb IIIC T85C...T120C Ta = -15 C to +70 C Db (Canada) Type 4X, IP67</p> <p>ATEX – FM14ATEX0059X: II 2 D Ex tb IIIC T85°C ... T120°C Db Ta = -15°C to +70°C IP67</p> <p>IEC – IECEx FMG 14.0028X: Ex tb IIIC T85°C ... T120°C Ta = -15°C to +70°C IP67</p>

The following approval standards are applicable:

NEMA 250:2003, ANSI/IEC 60529:2004, C22.2 No. 94:2001, C22.2 No. 157:2012, C22.2 No. 213:2012, C22.2 No. 1010.1:2009, EN60079-0:2018, EN60079-1:2014, EN60079-11:2012, EN60079-26:2015, EN60079-15:2010, IEC60079-1:2014 IEC60079-11:2011, FM3600:2018, FM3610:2018, FM3611:2018, FM3615:2018, FM3616:2018, FM3810:2018, ANSI/ISA UL60079-0:2014, ANSI/ISA 60079-1:2009, ANSI/ISA 60079-11:2014, ANSI/ISA 60079-15:2013, ANSI/ISA 60079-26:2017, C22.2 No. 0.4:2017, C22.2 No. 0.5:2016, C22.2 No. 30:2016, CAN/CSA 60079-0:2015, CAN/CSA 60079-1:2016, CAN/CSA 60079-11:2014, CAN/CSA 60079-15:2016, C22.2 No. 60529:2016, EN 60079-0:2018, EN 60079-26:2015, EN 60079-31:2014, EN 60529:1991+A1:2000+A2:2013, IEC 60079-0:2017, IEC 60079-15:2017, IEC 60079-31:2013

JM4 Material Properties of Probe Partition Well

Material	Standard	Minimum Wall Thickness inch (mm)	Tensile Strength Minimum (ksi)	Yield Strength Minimum (ksi)
Stainless Steel	ASTM A276	.057 (1.46)	75	30
Hastelloy C-276	ASTM B574	.057 (1.46)	100	41
Monel 400	ASTM B164	.057 (1.46)	70	25

Temperature ranges are tabulated in section 2.6.2.

SPECIAL CONDITIONS OF USE:

- The enclosure contains aluminum and is considered to present a potential risk of ignition by impact or friction. Care must be taken during installation and use to prevent impact or friction.
- To maintain the T4 temperature code care shall be taken to ensure the enclosure temperature does not exceed +70 °C (+158 °F).
- The risk of electrostatic discharge shall be minimized at installation, following the direction given in the instruction.
- For installation with ambient temperature of +70 °C (+158 °F), refer to the manufacturer's instructions for guidance on proper selection of conductors.
- Provisions shall be made to provide transient overvoltage protection to a level not to exceed 119 Vdc.
- WARNING – Explosion Hazard** do not disconnect equipment when flammable or combustible atmosphere is present
- When equipment is used in explosive dust atmospheres, the end user shall take precautions so that the thermal effects of the process temperature shall limit the equipment enclosure and probe surface temperatures to not exceed the required installation location temperature and shall be between T85 °C (185 °F) and T120 °C (248 °F).
- For the Ex db rated Jupiter JM4, consult the manufacturer for dimensional information on the flameproof joints for repair.
- All unused device openings must be closed using a suitably certified plug.
- Temperature codes for the ratings Ex db IIB+H2, are defined by the following table:

Maximum Process Temperature	Temperature Class
From 0°C to 70°C	T6
From 71°C to 90°C	T5
From 91°C to 125°C	T4
From 126°C to 190°C	T3
From 191°C to 290°C	T2
From 291°C to 440°C	T1

NOTES:

- For Explosion-proof installations the I.S. ground terminal shall be connected to appropriate intrinsically safe ground in accordance with the Canadian Electrical code (CEC) or the national electrical code (NEC). For intrinsically safe installations the I.S. ground terminal does not require grounding.
- Manufacturer's installation instructions supplied with the protective barrier and the CEC or the NEC must be followed when installing this equipment. Barrier must be certified for Canadian & U.S. installation.
- Control equipment connected to protective barriers must not use or generate more than 250 VDC or VRMS.
- Agency approved dust tight seals must be used when transmitter is installed in Class II & III environments.
- For supply connections, use wire suitable for the operating temperature.
- Agency approved barriers with linear output characteristics must be used.

2.5.1 Agency Specifications – FM/CSA Intrinsically Safe Installation

HAZARDOUS LOCATION
 CLASS II, DIVISION 2, TYPE I, INTRINSICALLY SAFE FOR:
 CLASS DIVISION GROUPS A, B, C & D
 CLASS DIVISION GROUPS E & F GROUPS 1 & 2 (CLASS II)
 CLASS II

ENTITY
 $V_{max} = 28.6V$
 $I_{max} = 140mA$
 $C_{eq} = 1nF$
 $L_{eq} = 4.4\mu H$
 $T = 7\mu s$

NON-HAZARDOUS LOCATION
LIMITING VALUES
 $V_{oc} = 28.6V$ $C_{eq} = 1nF$
 $I_{sc} = 140mA$ $L_{eq} = 27\mu H$

THE VOLTAGE (V_{max}) AND CURRENT (I_{max}), WHICH THE TRANSMITTER CAN PROVIDE MUST BE EQUAL TO OR GREATER THAN THE MAXIMUM OPEN CIRCUIT VOLTAGE (V_{oc} OR V_{+}) AND THE MAXIMUM SHORT CIRCUIT CURRENT (I_{sc} OR I_{-}), WHICH CAN BE DELIVERED BY THE SOURCE DEVICE. IN ADDITION, THE MAXIMUM CAPACITANCE (C) AND INDUCTANCE (L) OF THE LOAD AND THE CAPACITANCE AND INDUCTANCE OF THE INTERCONNECTING WIRING MUST BE EQUAL TO LESS THAN THE CAPACITANCE (C_{eq}) OR THE INDUCTANCE (L_{eq}), WHICH CAN BE DELIVERED BY THE SOURCE DEVICE.

JUPITER JM4-51XX-XXX

C SPECIAL CONDITIONS OF USE:

- THE ENCLOSURE CONTAINS ALUMINUM AND IS CONSIDERED TO PRESENT A POTENTIAL RISK OF IGNITION BY IMPACT OR FRICTION. CARE MUST BE TAKEN DURING INSTALLATION AND USE TO PREVENT IMPACT OR FRICTION.
- TO MAINTAIN THE 14 TEMPERATURE CODE CARE SHALL BE TAKEN TO ENSURE THE ENCLOSURE TEMPERATURE DOES NOT EXCEED 70°C.
- THE RISK OF ELLC (ELECTROSTATIC DISCHARGE) SHALL BE MINIMIZED AT INSTALLATION, FOLLOWING THE DIRECTION GIVEN IN THE INSTRUCTION.
- CONSULT THE ORIGINAL MANUFACTURER FOR INFORMATION IN THE DIMENSIONS OF FLAMEPROOF JOINTS.
- FOR INSTALLATION WITH AMBIENT TEMPERATURE OF 70°F, REFER TO THE MANUFACTURER'S INSTRUCTIONS FOR SIZING AND PROPER SELECTION OF CONDUITS.
- PROVISIONS SHALL BE MADE TO PROVIDE TRANSPARENT OVERVOLTAGE PROTECTION TO A LEVEL NOT TO EXCEED 115VDC.
- WARNING – EXPLOSION HAZARD: DO NOT DISCONNECT EQUIPMENT WHEN FLAMMABLE OR COMBUSTIBLE ATMOSPHERE IS PRESENT.**
- FOR THE EX-RATED JUPITER JM4, CONSULT THE MANUFACTURER FOR DIMENSIONAL INFORMATION ON THE FLAMEPROOF JOINTS (O-RINGS).
- ALL UNUSED DEVICE OPENINGS MUST BE CLOSED USING A SUITABLY CERTIFIED PLUG.
- TEMPERATURE CODES FOR THE RATINGS Ex (d) IIC₀ ARE DEFINED BY THE FOLLOWING TABLE:

Maximum Process Temperature(°F)	Temperature Class
From 0°C to 70°C	T6
From 71°C to 90°C	T5
From 91°C to 125°C	T4
From 126°C to 150°C	T3
From 151°C to 250°C	T2
From 251°C to 440°C	T1

C NOTES:

- FOR EXPLOSIONPROOF INSTALLATIONS THE U.S. GROUND TERMINAL SHALL BE CONNECTED TO APPROPRIATE INTRINSICALLY SAFE GROUND IN ACCORDANCE WITH THE CANADIAN ELECTRICAL CODE (CEC) OR THE NATIONAL ELECTRICAL CODE (NEC). FOR INTRINSICALLY SAFE INSTALLATIONS THE U.S. GROUND TERMINAL DOES NOT REQUIRE GROUNDING.
- MANUFACTURER'S INSTALLATION INSTRUCTIONS SUPPLIED WITH THE PROTECTIVE BARRIER AND THE DECOR THE NEC MUST BE FOLLOWED WHEN INSTALLING THIS EQUIPMENT. BARRIER MUST BE CERTIFIED FOR CANADIAN & U.S. INSTALLATION.
- CONTROL EQUIPMENT CONNECTED TO PROTECTIVE BARRIERS MUST NOT USE OR GENERATE MORE THAN 250 VDC OR 50 WATTS.
- AGENCY APPROVED TIGHT SEALS MUST BE USED WHEN TRANSMITTER IS INSTALLED IN CLASS II & III ENVIRONMENTS.
- FOR SUPPLY CONNECTIONS, USE WIRE SUITABLE FOR THE OPERATING TEMPERATURE.
- AGENCY APPROVED BARRIERS WITH LINEAR OUTPUT CHARACTERISTICS MUST BE USED.

AGENCY LISTED DRAWING
 ALL REVISIONS TO THIS DRAWING REQUIRE QA APPROVAL

705 ENTERPRISE ST, AURORA IL 60504
 AREA CODE 630/969-4000
099-5074 SHEET 2 OF 3

2.5.2 Agency Specifications – FM/CSA Intrinsically Safe FOUNDATION fieldbus™ Installation

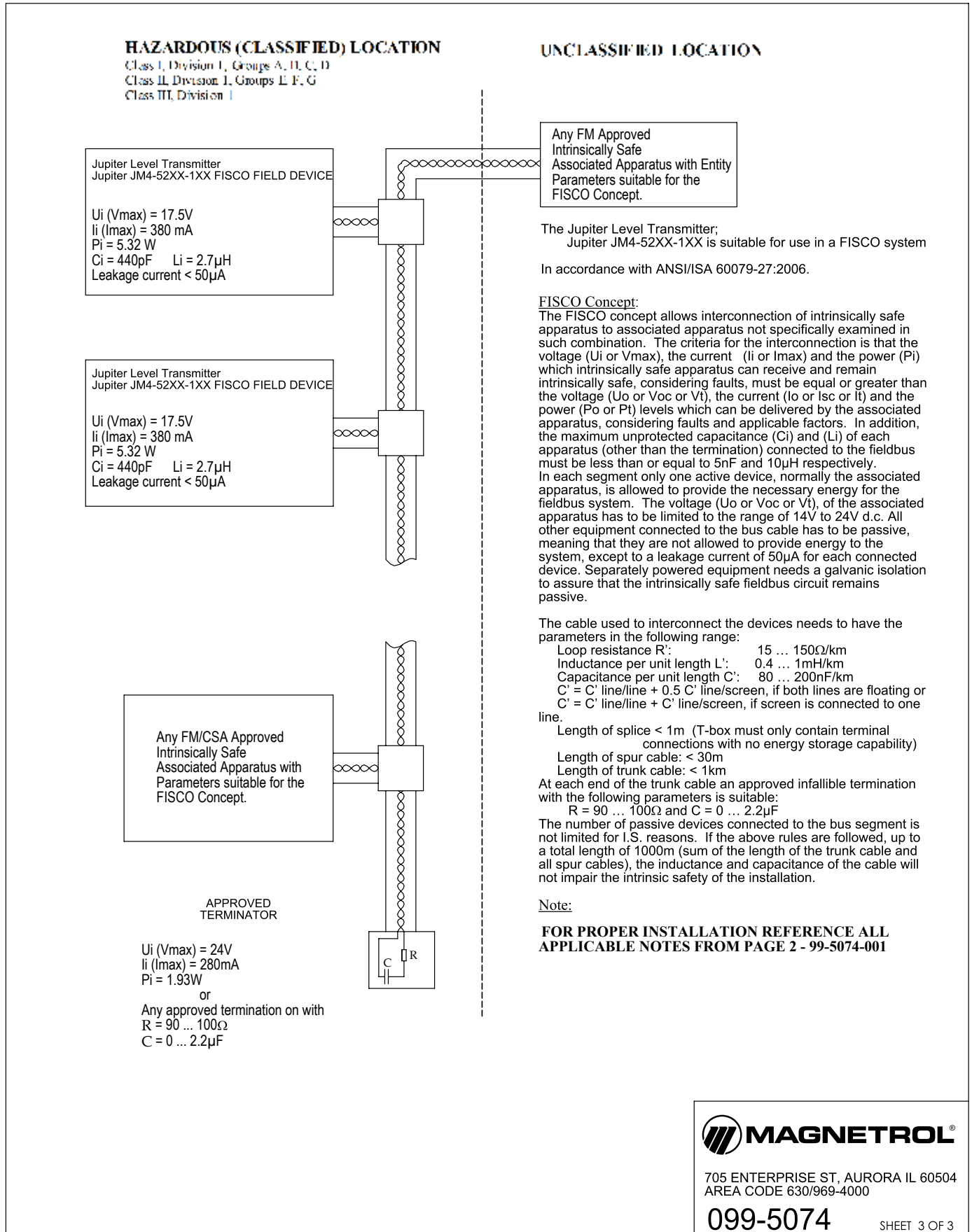

705 ENTERPRISE ST, AURORA IL 60504
 AREA CODE 630/969-4000

099-5074

SHEET 3 OF 3

2.6 Specifications

2.6.1 Functional/Physical

System Design

Measurement Principle Magnetostriction-based mechanical response signal

Input

Measured Variable Level, response signal time of flight

Span 6 inches to 400 inches (15 cm to 999 cm)

Output

Type 4 to 20 mA with HART: 3.8 mA to 20.5 mA useable (per NAMUR NE43)

FOUNDATION fieldbus™: H1 (ITK Ver. 6.1.1)

Resolution Analog: 0.003 mA

Digital Display: 1 mm

Loop Resistance 591 ohms @ 24 VDC and 22 mA

Diagnostic Alarm Selectable: 3.6 mA, 22 mA (meets requirements of NAMUR NE 43), or HOLD last output

Damping Adjustable 0-10 seconds

User Interface

Keypad 4-button menu-driven data entry

Display Graphic liquid crystal display with viewable echo curve

Digital Communication HART Version 7—with Field Communicator, FOUNDATION fieldbus™, DTM (PACTware™), AMS, FDT, EDDL

Menu Languages Transmitter LCD: English, French, German, Spanish, Russian, Portuguese
HART DD: English, French, German, Spanish, Russian, Chinese, Portuguese

Foundation fieldbus™ Host System: English

Power (at transmitter terminals)

HART: General Purpose (Weather proof)/Intrinsically Safe/Explosion-proof:

16 to 36 VDC

11 VDC minimum under certain conditions (refer to Section 2.6.5)

FOUNDATION fieldbus™: FISCO 9 to 17.5 VDC

FISCO, FNICO, Explosion Proof, General Purpose (Weather Proof): 9 to 32 VDC

Housing

Material IP67/die cast aluminum A413 (<0.6% copper); optional 316 stainless steel

Net/Gross Weight Aluminum: 4.5 lbs. (2.0 kg)

Stainless Steel: 10.0 lbs. (4.50 kg)

Overall Dimensions Transmitter Head: H 8.34" (212 mm) x W 4.03" (102 mm) x D 7.56" (192 mm)

Cable Entry 1/2" NPT or M20

SIL 2 Hardware (Safety Integrity Level) Safe Failure Fraction = 93.1% for Single Float version,

91.9% for Dual Float version (HART only)

(Full FMEDA report available upon request)

Performance

Linearity 0.030 in. (.8 mm) or 0.01% of probe length, whichever is greater

Accuracy ±0.01% full scale or ±0.05 in (1.3 mm), whichever is greater

Resolution .014" (.4 mm)

Repeatability ±0.005% of full span or 0.014 in, whichever is greater

Response Time 1 second

Initialization Time Less than 10 seconds

Ambient Temperature Effect Approx. ±0.02% of probe length/degree C

Execution Time 15 msec (30 msec PID, Signal Characterizer Block)

Calibration Points Up to 5-point calibration (upon request)

2.6 Specifications (continued)

FOUNDATION fieldbus™

ITK Version	6.1.1
H1 Device Class	Link Master (LAS)—selectable ON/OFF
H1 Profile Class	31PS, 32L
Function Blocks	(6) AI, (2) Transducer, (1) Resource, (1) Arithmetic, (1) Input Selector, (1) Signal Characterizer, (2) PID, (1) Integrator
Quiescent Current	15 mA
Execution Time	15 msec (30 msec PID, Signal Characterizer Block)

Environment

Ambient Temperature Range	Transmitter:	-40°F to +158°F (-40°C to +70°C)
	Display:	-5°F to +158°F (-20°C to +70°C)
Storage Temperature		-50°F to +185°F (-46°C to +85°C)
Process Pressure (Direct Insertion)		Vacuum to 3000 psig (207bar)
Humidity		0 to 99%, non-condensing
Electromagnetic Compatibility		Meets CE requirement (EN 61326) and NAMUR NE 21
Surge Protection		Meets CE EN 61326 (1000V)
Shock/Vibration		ANSI/ISA-S71.03 Class SA1 (Shock); ANSI/ISA-S71.03 Class VC2 (Vibration)

Process Conditions

Process Temperature	External Mount:	-320°F to +850°F (-196°C to +450°C)
	Direct Insertion:	-320°F to +800°F (-196°C to +425°C)
Process Pressure	Direct Insertion:	Vacuum to 3000 psig (207 bar)

2.6.2 Probe Selection Guide

JM4 Probe	Temperature Range	Pressure Range (Direct Insertion)
Standard	-50 to 450 °F (-46 to 232 °C)	Vacuum to 3000 psig (207 bar)
High Temperature	-50 to 800 °F (-46 to 427 °C)	Vacuum to 3000 psig (207 bar)
Cryogenic	-320 to 158 °F (-196 to 70 °C)	Vacuum to 3000 psig (207 bar)

2.6.3 Probe Specifications

Probe Diameter	0.625 inches (1.59 cm)
Process Connection	¾" NPT, 2" NPT, 1" BSP, 2" BSP ANSI or DIN Flanges
Materials	Standard: 316 SS, nickel, Teflon®, brass, silicone High Temperature: 316 SS, ceramic, brass, nickel, mica Cryogenic: 316 SS, silicone, nickel, Teflon®, brass

2.6.4 Physical Specifications - Transmitter

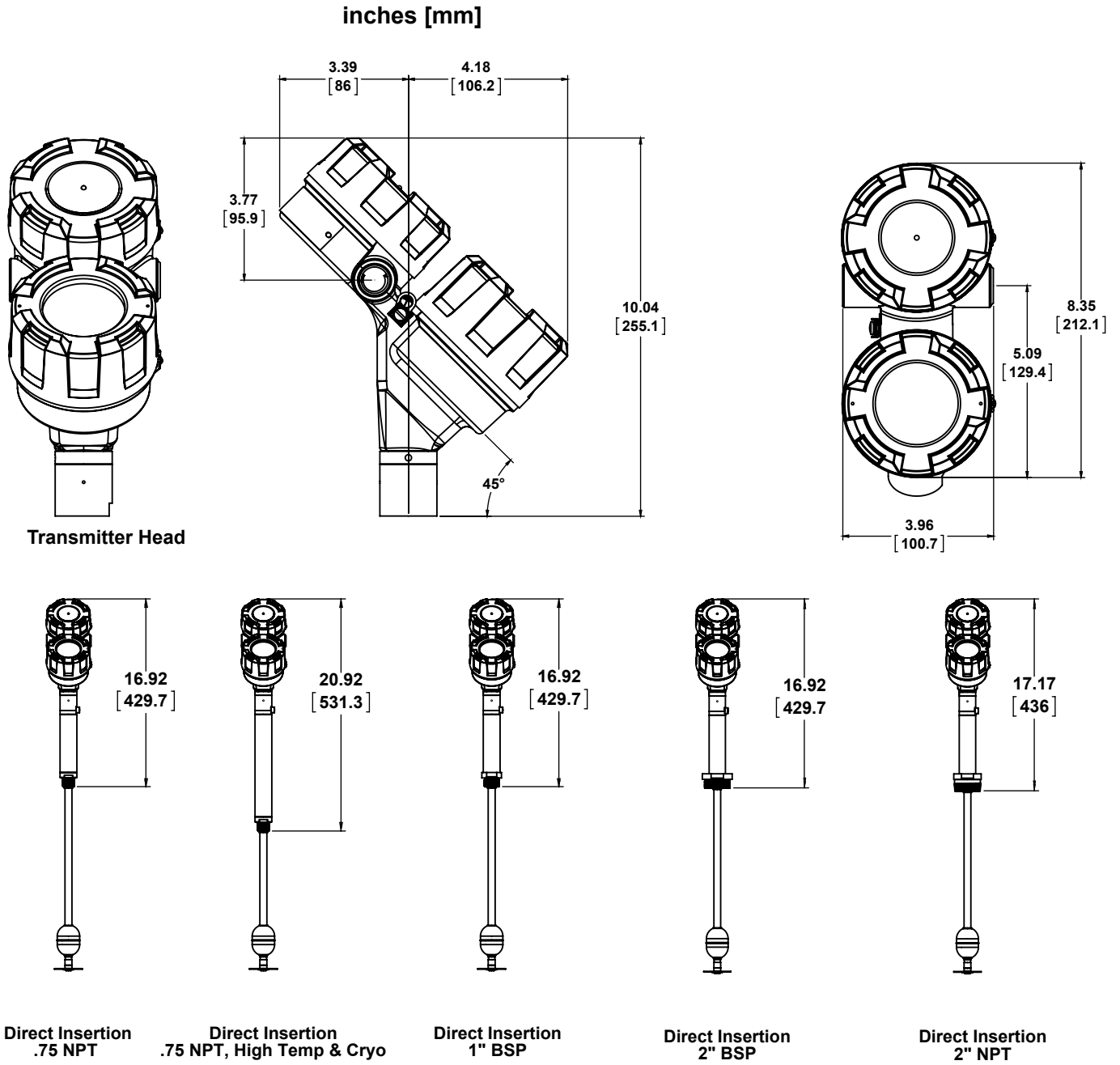

2.6.4 Physical Specifications - Transmitter

inches [mm]

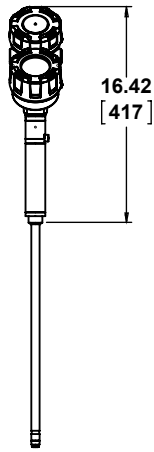

External Top Mount

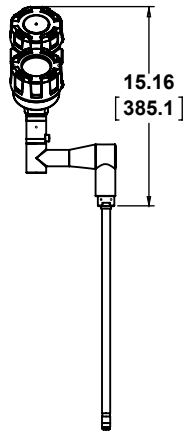

External Top Mount Offset

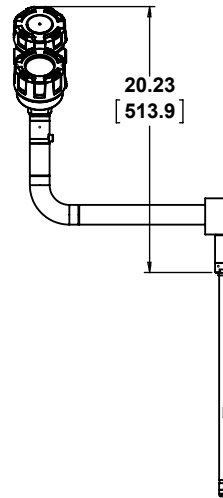

External Top Mount Offset, Cryo

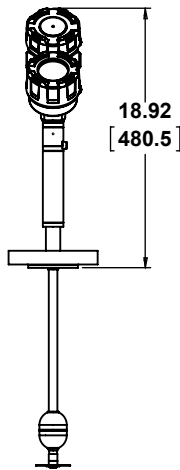

Direct Insertion Flange

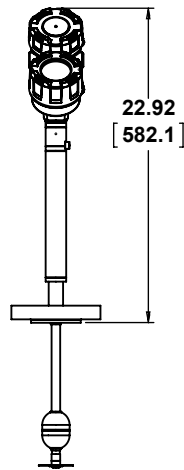

Direct Insertion Flang, High Temp & Cryo

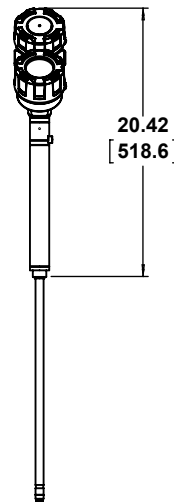

External Top Mount High Temp & Cryo

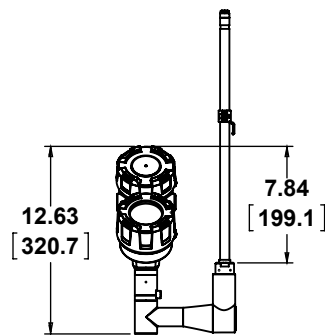

External Bottom Mount Offset

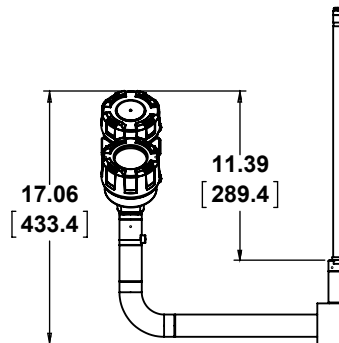

External Bottom Mount Offset, Cryo

2.6.5 Power Supply Requirements

2.6.5.1 Safe Operating Area

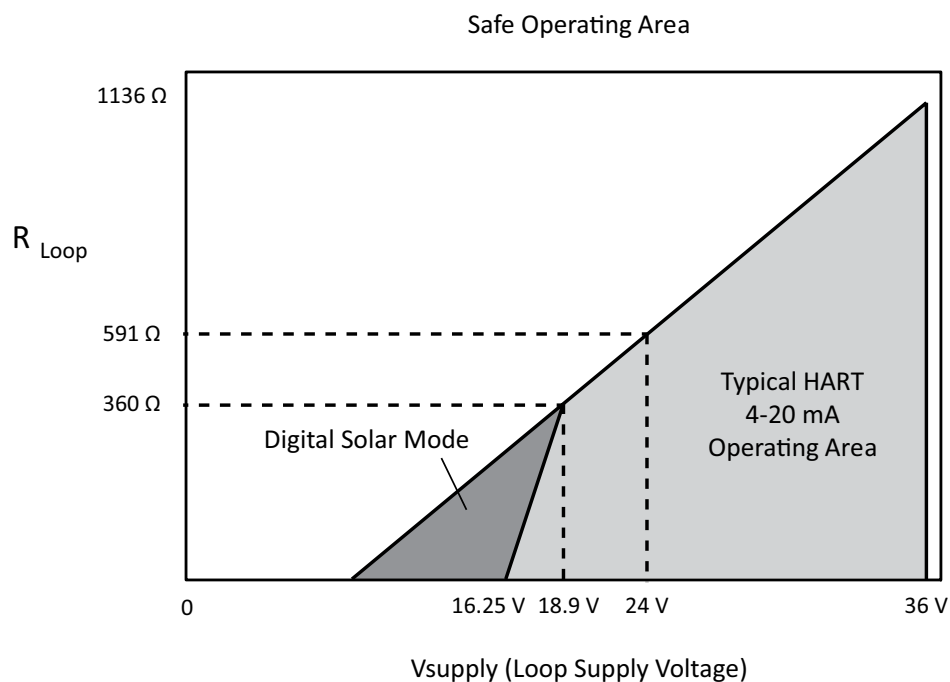

2.5.5.2 Terminal Voltage

Operational Mode	Current Consumption	Vmin	Vmax
HART			
General Purpose	4mA	16.25V	36V
	20mA	11V	36V
Intrinsically Safe	4mA	16.25V	28.6V
	20mA	11V	28.6V
Explosion Proof	4mA	16.25V	36V
	20mA	11V	36V
Fixed Current-Solar Power Operation (PV transmitter via HART)			
General Purpose	10mA ^①	11V	36V
Intrinsically Safe	10mA ^①	11V	28.6V
HART Multi-Drop Mode (Fixed Current)			
Standard	4mA ^①	16.25V	36V
Intrinsically Safe1	4mA ^①	16.25V	28.6V
FOUNDATION fieldbus			
Supply/Terminal Voltage	9V to 17.5V	9V to 17.5V	9V to 17.5V

① Start-up current 12mA minimum.

2.7 Model Number

Transmitter

1 2 3 | BASIC MODEL NUMBER

JM4	Jupiter 4th Generation Magnetostrictive Level Transmitter
-----	---

4 | POWER

5	24 VDC Two-Wire
---	-----------------

5 | SIGNAL OUTPUT

1	4-20 mA with HART®
2	FOUNDATION fieldbus™ Communications

6 | SAFETY OPTIONS

0	None required for FOUNDATION fieldbus™
1	SIL 2 Hardware SEE NOTE 1

7 | ACCESSORIES/MOUNTING

0	No Digital Display and Keypad - Integral
1	No Digital Display and Keypad - Remote 36" (0.91m) SEE NOTE 2
2	No Digital Display and Keypad - Remote 144" (3.6m) SEE NOTE 2
A	Digital Display and Keypad - Integral
B	Digital Display and Keypad - Remote 36" (0.91m) SEE NOTE 2
C	Digital Display and Keypad - Remote 144" (3.6m) SEE NOTE 2

8 | AREA CLASSIFICATION

0	General Purpose, Weatherproof (IP 67)
1	Intrinsically Safe / FISCO (cFMus)
3	Explosion-Proof / FNICO (cFMus)
A	Intrinsically Safe (ATEX & IEC)
B	Flame-Proof (ATEX & IEC)
C	Ex n (ATEX & IEC)
D	Dust Ex (ATEX & IEC)

9 | HOUSING

1	Aluminum, Dual-Component
2	316 SS, Dual-Component

10 | CONDUIT CONNECTION

0	½" NPT
1	M20
2	½" NPT with Sunshade
3	M20 with Sunshade

NOTES:

- ¹ 3rd Party FMEDA report available
- ² Remote-mount transmitter not available with XP / Flame Proof approvals

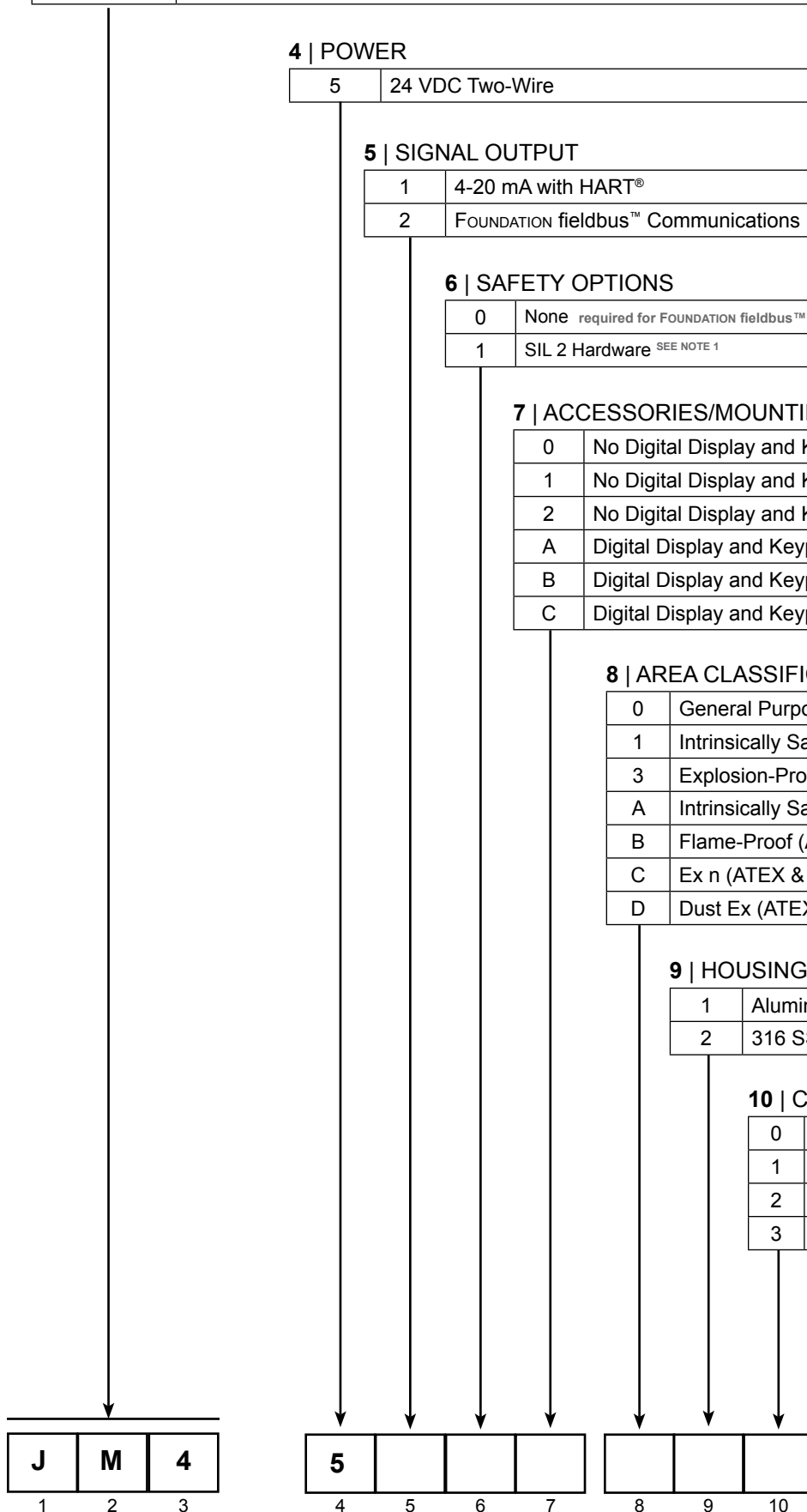

Model Number

External Mount Probe

1 | TECHNOLOGY

2	Jupiter Magnetostrictive Probes - Model JM4
---	---

2 | MEASUREMENT SYSTEM

A	English <i>Probe length to be provided in inches</i>
C	Metric <i>Probe length to be provided in centimeters</i>

3 | CONFIGURATION

E	STANDARD Top Mount	<i>suitable for process temperatures -40 to +500 °F (-40 to +260 °C)</i>
F	STANDARD Top Mount Offset	
H	STANDARD Bottom Mount Offset	
K	HIGH-TEMP Top Mount	<i>suitable for process temperatures +501 to +850 °F (+261 to +454 °C)</i>
L	HIGH-TEMP Top Mount Offset	
M	HIGH-TEMP Bottom Mount Offset	
R	CRYOGENIC Top Mount	<i>suitable for process temperatures -320 to +150 °F (-196 to +66 °C)</i>
S	CRYOGENIC Top Mount Offset	
T	CRYOGENIC Bottom Mount Offset	

4 5 | MOUNTING SIDE

0 0	Left-side MLI Mount
0 1	Right-side MLI Mount

6 | PROBE MATERIAL OF CONSTRUCTION

A	Powder-Coated Aluminum Sensor Enclosure with 316 SS Probe <small>SEE NOTE 1</small>
1	316 SS Sensor Enclosure with 316 SS Probe

¹ Available only with Digit 3, Options F, H, L, M

7 | PROBE OPTIONS AND HAZARDOUS LOCATION APPROVALS

Standard Probe	
F	ATEX & IEC Flameproof approval only
N	All other approvals (XP, IS, NI)
Vibration Resistant Probe <small>SEE NOTE 2</small>	
G	ATEX & IEC Flameproof approval only
V	All other approvals (XP, IS, NI)

² Available only with Digit 3, Options F, H, L, M

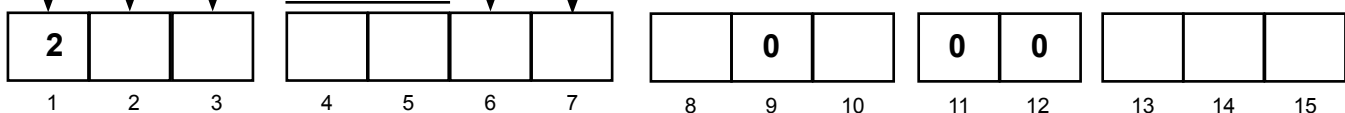

Model Number Continued

External Mount Probe

8 | CHAMBER SIZE (FOR MOUNTING HARDWARE)

0	No mounting clamps required.
---	------------------------------

Select from these options if chamber DOES NOT contain high-temp insulation

1	2" (or if digit 20 of MLI model code is 1, 2, or 7)
2	2½" (or if digit 20 of MLI model code is 3, 4, 5, or 6)
3	3" (or if digit 20 of MLI model code is A, B, C, or D)
4	4" (or if digit 20 of MLI model code is E, F, G, H, or J)
5	¾" (for Atlas Top Mount Configuration only)

Select from these options if chamber DOES contain high-temp insulation

E	2" (or if digit 20 of MLI model code is 1, 2, or 7)
F	2½" (or if digit 20 of MLI model code is 3, 4, 5, or 6)
G	3" (or if digit 20 of MLI model code is A, B, C, or D)
H	4" (or if digit 20 of MLI model code is E, F, G, H, or J)
J	¾" (for Atlas Top Mount Configuration only)

10 | LEVEL/INTERFACE MEASUREMENT PREFERENCE

1	Measure Only the Total Liquid Level
2	Measure Only the Interface Level
3	Measure Both Total and Interface Level

13 14 15 | PROBE LENGTH – max. 400" (999 cm)

X X X	Example: 87 inches = 087 <i>Code 2 must be "A"</i> Example: 120 centimeters = 120 <i>Code 2 must be "C"</i>
-------	--

Note: Maximum Probe Length = 400 inches (999 cm)
(limited to 192 inches (487 cm) when digit 3 = K, L or M)

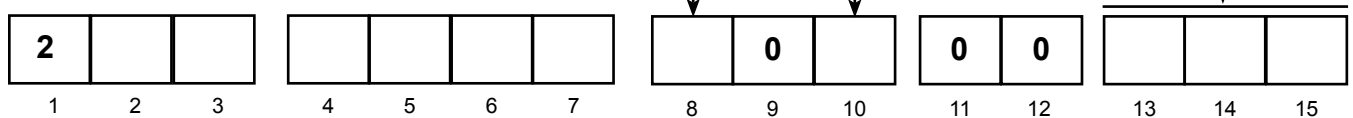

Model Number

Direct Insertion Probe

1 | TECHNOLOGY

2	Jupiter Magnetostrictive Probes - Model JM4
---	---

2 | MEASUREMENT SYSTEM

A	English <i>Probe length to be provided in inches</i>
C	Metric <i>Probe length to be provided in centimeters</i>

3 | CONFIGURATION

1	Standard	<i>process temperatures between -40 to +500 °F (-40 to +260 °C)</i>
2	High-Temperature ^{SEE NOTE 1}	<i>process temperatures between +501 to +800 °F (+261 to +425 °C)</i>
8	Cryogenic	<i>process temperatures between -320 to +150 °F (-196 to +66 °C)</i>

¹ Probe lengths up to 192 inches (488 cm). Consult factory for longer lengths.

4 & 5 | PROCESS CONNECTION SIZE & TYPE

Threaded

11	¾" NPT
41	2" NPT

22	1" BSP
42	2" BSP

ASME Flanges

43	2" 150# Raised Face
44	2" 300# Raised Face
45	2" 600# Raised Face
47	2" 900/1500# Raised Face
53	3" 150# Raised Face
54	3" 300# Raised Face
55	3" 600# Raised Face

56	3" 900# Raised Face
57	3" 1500# Raised Face
63	4" 150# Raised Face
64	4" 300# Raised Face
65	4" 600# Raised Face
66	4" 900# Raised Face
67	4" 1500# Raised Face

EN 1092-1 Flanges

CB	DN 40 : PN 16/25/40 Type A
CC	DN 40 : PN 63/100 Type B2
DA	DN 50 : PN 16 Type A
DB	DN 50 : PN 25/40 Type A
DD	DN 50 : PN 63 Type B2
DE	DN 50 : PN 100 Type B2
EA	DN 80 : PN 16 Type A
EB	DN 80 : PN 25/40 Type A

ED	DN 80 : PN 63 Type B2
EE	DN 80 : PN 100 Type B2
FA	DN 100 : PN 16 Type A
FB	DN 100 : PN 25/40 Type A
FD	DN 100 : PN 63 Type B2
FE	DN 100 : PN 100 Type B2
FF	DN 100 : PN 160 Type B2
FG	DN 100 : PN 250 Type B2

6 | MATERIAL OF CONSTRUCTION

A	316 SS
B	Hastelloy C276
C	Monel 400
L	316 SS w/Teflon-S coating on probe tubing and float ^{SEE NOTE 2}
P	316 SS w/PFA coating on probe tubing and float ^{SEE NOTE 2}

² ID of float to be enlarged to accommodate coating

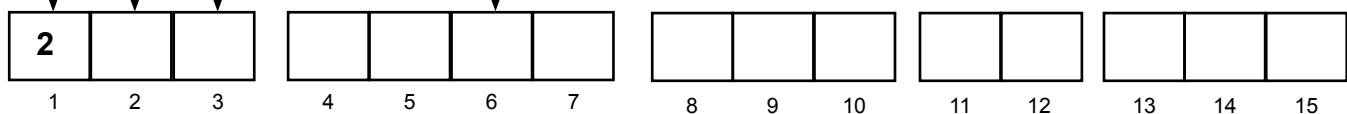

Model Number Continued

Direct Insertion Probe

7 | PROBE OPTIONS AND HAZARDOUS LOCATION APPROVALS

F	ATEX & IEC Flameproof approval only
N	All other approvals (XP, IS, NI)

8 | INSTALLATION CONSIDERATIONS

N	Direct Insertion unit mounted in vessel without stilling well
C	Direct Insertion unit mounted in chamber, bridle, or stilling well <small>SEE NOTE 3</small>

³ Refer to sizing chart for chambers and stilling wells on page 16 of bulletin ORI-150.

9 | CONSTRUCTION CODE

0	Industrial Grade
K	ASME B31.1
L	ASME B31.3
M	ASME B31.3 & NACE MR0103/MR0175
N	Industrial Grade & NACE MR0103/MR0175

10 | LEVEL/INTERFACE MEASUREMENT PREFERENCE

1	Measure Only the Total Liquid Level
2	Measure Only the Interface Level
3	Measure Both Total and Interface Level

11 12 | MAGNETIC FLOAT(S)

See next page for our standard direct insertion float offerings. If a listed float does not meet your application requirements, consult factory for a custom design.

13 14 15 | PROBE LENGTH – max. 400" (999 cm)

X X X	Example: 87 inches = 087 <small>Code 2 must be "A"</small> Example: 120 centimeters = 120 <small>Code 2 must be "C"</small>
-------	--

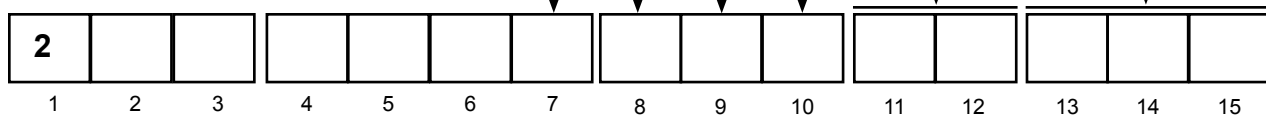

Model Number Continued

Direct Insertion Probe — Float Selection

11 12 | MAGNETIC FLOAT(S)

Direct Insertion Total Level Float (uppermost liquid layer)

Minimum Liquid Specific Gravity	316/316L SS	Titanium	Hastelloy® C	Hygienic Service 316/316L SS SF1: 20 µin (0.51 µm)	Hygienic Service 316/316L SS SF4: 15 µin (0.38 µm)
≥ 0.86	AA 2.0" (51 mm) dia.	BA 2.0" (51 mm) dia.	CA 1.85" (47 mm) dia.	DA 2.0" (51 mm) dia.	FA 2.0" (51 mm) dia.
≥ 0.83	AA 2.0" (51 mm) dia.	BA 2.0" (51 mm) dia.	CB 2.25" (57 mm) dia.	DA 2.0" (51 mm) dia.	FA 2.0" (51 mm) dia.
≥ 0.7	AB 2.3" (58 mm) dia.	BA 2.0" (51 mm) dia.	CB 2.25" (57 mm) dia.	DB 2.3" (58 mm) dia.	FB 2.3" (58 mm) dia.
≥ 0.68	AB 2.3" (58 mm) dia.	BB 2.25" (57 mm) dia.	99 consult factory	DB 2.3" (58 mm) dia.	FB 2.3" (58 mm) dia.
≥ 0.64	AC 2.5" (64 mm) dia.	BB 2.25" (57 mm) dia.	99 consult factory	DC 2.5" (64 mm) dia.	FC 2.5" (64 mm) dia.
≥ 0.52	99 consult factory dia.	BB 2.25" (57 mm) dia.	99 consult factory	99 consult factory	99 consult factory
< 0.52	99 consult factory	99 consult factory	99 consult factory	99 consult factory	99 consult factory

Direct Insertion Interface Level Float (lower or middle liquid layer)

Minimum Liquid Specific Gravities upper / lower	316/316L SS	Titanium	Hastelloy® C	Hygienic Service 316/316L SS SF1: 20 µin (0.51 µin)	Hygienic Service 316/316L SS SF4: 15 µin (0.38 µin)
sinks thru / floats on ≤ 0.89 / ≥ 1.00	MA 2.0" (51 mm) dia.	NA 2.0" (51 mm) dia.	PA 1.85" (47 mm) dia.	QA 2.0" (51 mm) dia.	RA 2.0" (51 mm) dia.
sinks thru / floats on ≤ 1.00 / ≥ 1.12	MB 2.0" (51 mm) dia.	NB 2.0" (51 mm) dia.	PB 1.85" (47 mm) dia.	QB 2.0" (51 mm) dia.	RB 2.0" (51 mm) dia.

Two Floats for Total Level and Interface Measurement

Code	Total	Interface
11	AA	MA
12	AB	
13	AC	
21	AA	MB
22	AB	
23	AC	
31	BA	NA

Code	Total	Interface
32	BB	NA
41	BA	NB
42	BB	
51	CA	PA
52	CB	
61	CA	PB
62	CB	

When utilizing two floats to measure total and interface liquid levels, reference the chart on the left to determine the appropriate float code to insert into the Jupiter model number.

If the desired combination is not shown, consult your local sales representative or Orion to inquire about a custom float design.

2.8 Parts

2.8.1 Replacement Parts

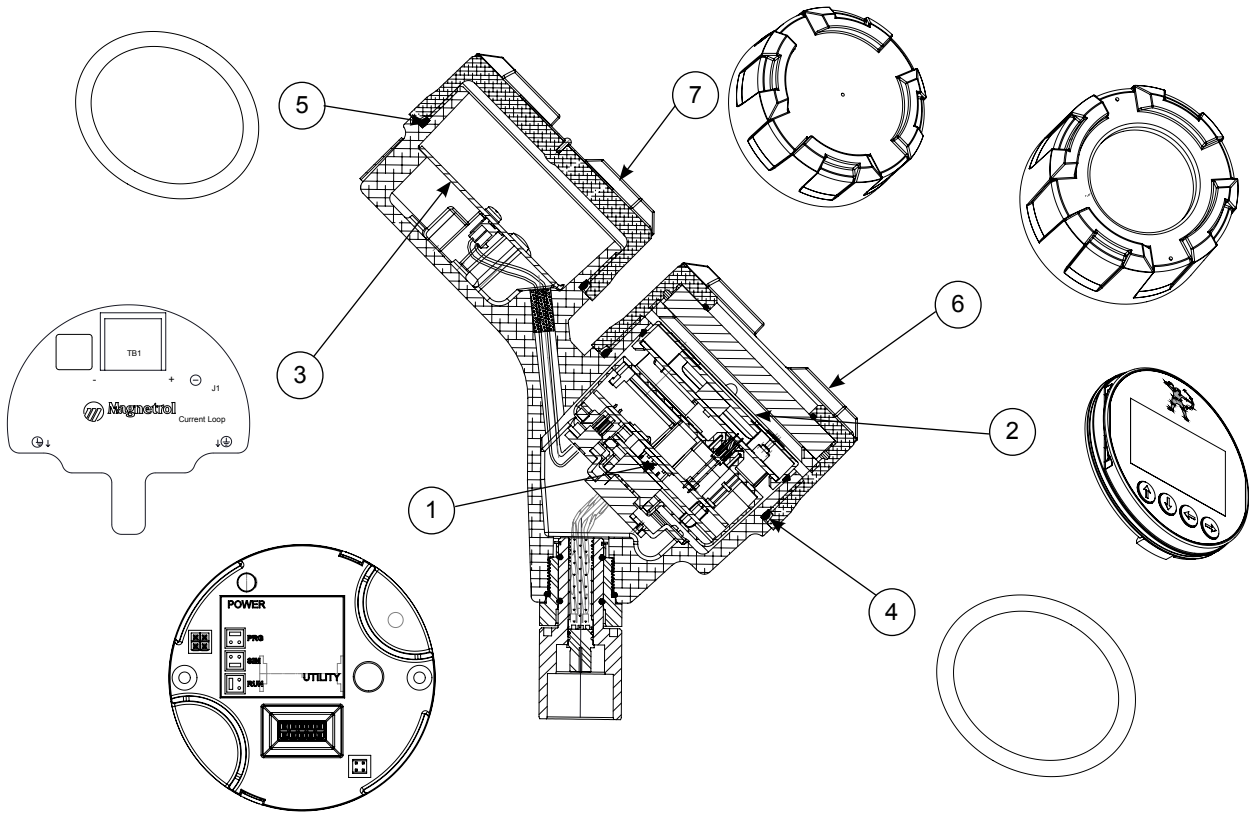

Part Number:

J	M	4
---	---	---

 —

5			
---	--	--	--

 —

--	--	--

(1) Electronic Module	
Digit 5	Replacement Part
1	031-2856-001
2	031-2856-002

(2) Display Module		
Digit 5	Digit 7	Replacement Part
1,2	0,1,2	-----
	A,B,C	031-2850-001

(3) Wiring PC Board	
Digit 5	Replacement Part
1	030-9165-001
2	030-9166-002

	Replacement Part
(4) "O" -ring	012-2201-237
(5) "O" -ring	012-2201-237

(6) Housing Cover			
Digits			Replacement Part
7	8	9	
0,1,2	0,1,3, A,B,C,D	1	004-9225-002
		2	004-9225-003
A,B,C	0,1,A	1	036-4413-005
	3	1	036-4413-001
A,B,C	0,1,3,A	2	036-4413-002
		1	036-4413-008
A,B,C	B,C,D	2	036-4413-009

(7) Housing Cover	
Digit 9	Replacement Part
1	004-9225-002
2	004-9225-003

Glossary

Accuracy The maximum positive and negative % deviation from the actual value over the total span.

ANSI *American National Standards Institute.*

CSA *Canadian Standards Association* Canadian, third party agency that qualifies the safety of electrical equipment.

Damping The mathematical averaging of a meter and/or output signal to stabilize the effects of a noisy process due to surface turbulence.

Default Values The main position of the menu structure that displays the primary measurement values of LEVEL, % OUTPUT, and LOOP. The transmitter returns to this position after 5 minutes of inactivity.

DVM/DMM Digital Volt Meter/Digital Multimeter.

Electromagnetic Energy The radiation that travels through space as electric and magnetic fields varying with position and time. Examples in increasing frequency: radio waves, microwave, infrared light, visible light, ultraviolet light, x-rays, gamma waves, and cosmic waves.

EM See Electromagnetic Energy.

EMI Electromagnetic Interference Electrical noise caused by electromagnetic fields that may affect electrical circuits, particularly low-power electronic devices.

EN European Normal Committee guidelines in EC countries that take precedence over local, country guidelines.

Ergonomic A mechanism that considers human capability in its design or function.

Explosion-Proof Enclosure An enclosure designed to withstand an explosion of gas or vapor within it and prevent the explosion from spreading outside the enclosure.

Fault A defect or failure in a circuit. The current (mA) value unit defaults to 3.6, 22, or Hold when a diagnostic condition occurs.

Feedthrough A small, connecting cavity between the main housing compartments, carrying the cable that supplies the operating energy to the measurement circuitry and returns the output value proportional to level. This cavity is potted to maintain the environmental isolation between the two compartments.

FM *Factory Mutual* American, third party agency that qualifies the safety of electrical equipment.

FSK Frequency Shift Keying.

Ground An electrical connection to the Earth's potential that is used as a reference for the system and electrical safety.

Grounded A state where no electrical potential exists between the ground (green) connection on the transmitter and the Earth or system ground.

HART *Highway Addressable Remote Transducer.* Protocol that uses the Bell 202 frequency shift keying (FSK) method to superimpose low level frequencies (1200/2000 Hz) on top of the standard 4–20 mA loop to provide digital communication.

HART ID See *Poll Address.*

Hazardous Area An area where flammable gases or vapors are or may be present in the air in quantities sufficient to produce explosive or ignitable mixtures.

IEC *International Electrotechnical Commission* Organization that sets international standards for electrical devices.

Increased Safety Designs and procedures that minimize sparks, arcs, and excessive temperatures in hazardous areas. Defined by the IEC as Zone 1 environments (Ex e).

Interface: Electrical A boundary between two related, electronic circuits.

Interface: Process A boundary between two or more immiscible liquids.

Intrinsic Safety A design or installation approach that limits the amount of energy that enters a hazardous area to eliminate the potential of creating an ignition source.

Level The present reading of the height of material in a vessel.

Linearity The worst case error calculated as a deviation from a perfect straight line drawn between two calibration points.

Loop The present reading of the 4–20 mA current output.

Low Voltage Directive A European Community requirement for electrical safety and related issues of devices using 50-1000 VDC or 75-1500 VAC.

Magnetic Level Indicator A magnetically coupled, liquid level indicator which isolates the process in a sealed non-magnetic piping column. Contrasting colored flags provide indication of level.

Magnetostrictive Utilizing the Wiedemann effect to create a mechanical torsion or twist in a ferromagnetic wire which occurs as a result of the interaction between an electrical pulse on the wire and a magnetic field from the float.

Measured Value The typical level measurement values used to track the level of a process: Level, % Output, and Loop.

Media The liquid material being measured by the level transmitter.

Multidrop The ability to install, wire, or communicate with multiple devices over one cable. Each device is given a unique address and ID.

Nonhazardous Area An area where no volatile mixtures of vapors/gas and oxygen will be found at any time. Also called General Purpose Area.

Non-incendive Equipment And wiring which in its normal operating condition is incapable of igniting a specific hazardous atmosphere or hazardous dust layer.

Offset The distance from the bottom of the tank to the bottom of the probe.

Password A numerical value up to 59999 protects stored configuration data from unauthorized manipulation.

Percent (%) Output The present reading as a fraction of the 16mA scale (4–20mA).

Poll Address A number between 1 and 15 which sets an address or location of a device in a multi-drop loop.

Probe A waveguide that propagates an electromagnetic pulse from the top of the tank into the process fluid.

Probe Length Exact measurement from the bottom of the process thread connection to the very bottom of the probe.

Range A value related to probe length (factory setting).

Repeatability The maximum error between two or more output readings of the same point.

RFI *Radio Frequency Interference Electrical* noise that can have an adverse affect on electrical circuits, particularly low-power devices.

Span The difference between the upper and lower limits of the range.

Specific Gravity (SG) The ratio of the density of a material to the density of water at the same conditions.

Tst Loop *Test Loop* Built-in system capability to test/calibrate a loop (or separate loop device) by driving the transmitter output to a particular value.

Trim 4/Trim 20 Built-in system capability to fine tune the 4 mA and 20 mA points so the transmitter output corresponds exactly to user's meter, DCS input, etc.

Two Wire An electrical instrument design that uses one set of wires to provide both the supply power and process measurement signal. The process measurement is achieved by varying the current of the loop. Also called *Loop Powered*.

Units The engineering units used to measure level in the system. The choices are in (inches) and cm (centimeters).

Service Policy

Owners of Magnetrol/Orion Instruments controls may request the return of a or any part of an instrument for complete rebuilding or replacement. They will be rebuilt or replaced promptly. Instruments returned under our service policy must be returned by prepaid transportation.

Magnetrol/Orion will repair or replace the control at no cost to the purchaser (or owner) other than transportation if:

1. Returned within the warranty period; and
2. The factory inspection finds the cause of the claim to be covered under the warranty.

If the trouble is the result of conditions beyond our control; or, is NOT covered by the warranty, there will be charges for labor and the parts required to rebuild or replace the equipment.

In some cases it may be expedient to ship replacement parts; or, in extreme cases a complete new instrument, to replace the original equipment before it is returned. If this is desired, notify the factory of both the model and serial numbers of the instrument to be replaced. In such cases, credit for the materials returned will be determined on the basis of the applicability of our warranty.

No claims for misapplication, labor, direct or consequential damage will be allowed.

Contact Technical Support:

Toll free 866-55-ORION or support@orioninstruments.com

Return Material Procedure

So that we may efficiently process any materials that are returned, it is essential that a "Return Material Authorization" (RMA) number be obtained from the factory, prior to the material's return. This is available through Magnetrol/Orion's local representative or by contacting the factory. Please supply the following information:

1. Company Name
2. Description of Material
3. Serial Number
4. Reason for Return
5. Application

Any unit that was used in a process must be properly cleaned in accordance with OSHA standards, before it is returned to the factory.

A Material Safety Data Sheet (MSDS) must accompany material that was used in any media.

All shipments returned to the factory must be by prepaid transportation.

All replacements will be shipped F.O.B. factory.

Notes

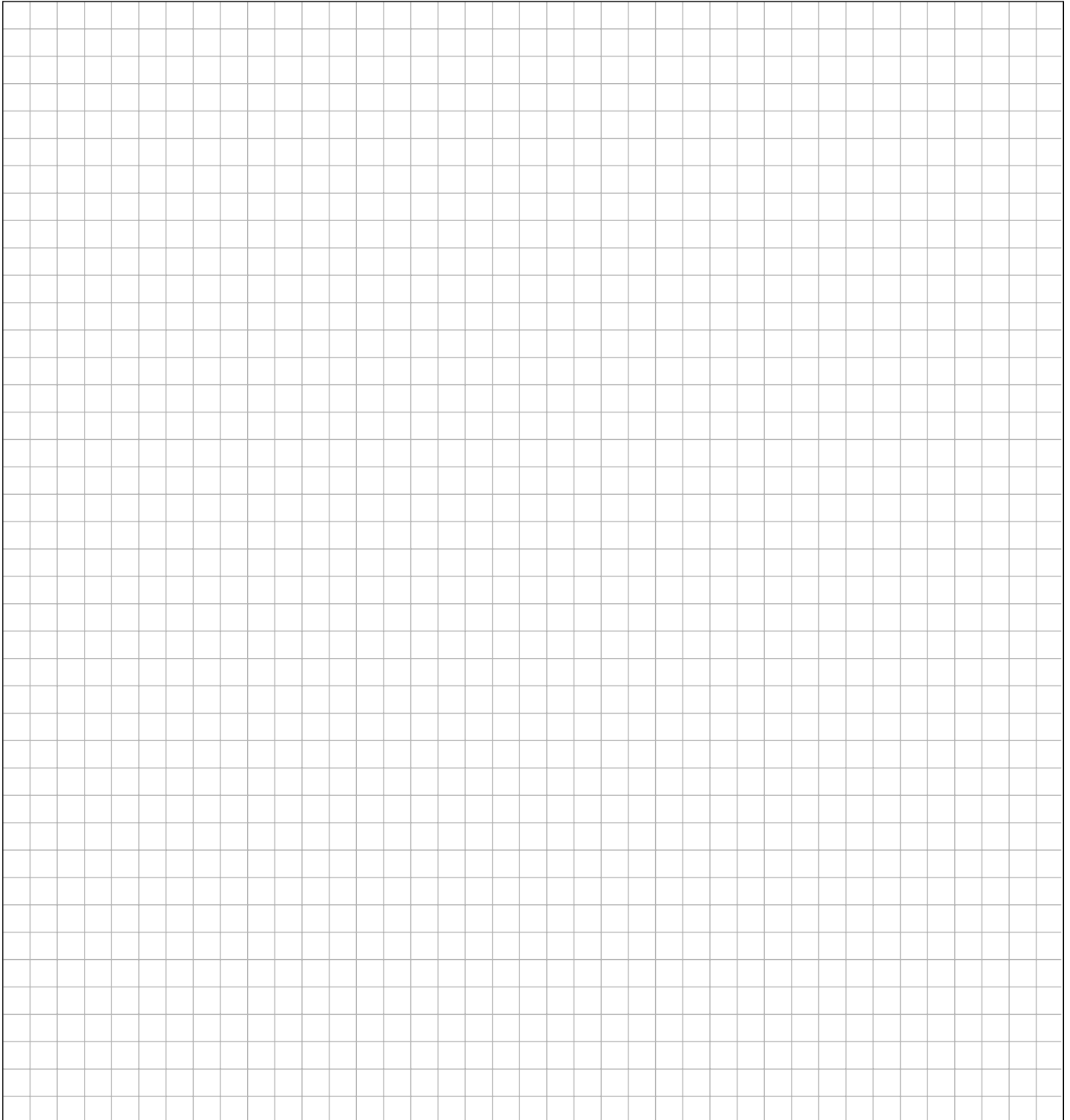



2105 Oak Villa Boulevard • Baton Rouge, Louisiana 70815 • 225-906-2343 • orioninstruments.com

Copyright © 2019 Magnetrol International, Incorporated

Magnetrol & Magnetrol logotype and Orion Instruments & Orion logotype are registered trademarks of Magnetrol International, Incorporated.

HART® is a registered trademark of the HART Communication Foundation

PACTware™ is trademark of PACTware Consortium

CSA logotype is a registered trademark of Canadian Standards Association

Viton® is a registered trademarks of DuPont Performance Elastomers.

Hastelloy® is a registered trademark of Haynes International, Inc.

Monel® is a registered trademark of Special Metals Corporation (Formerly Inco Alloys International)

Tri-Clamp® is a registered trademark of Ladish Co.

Bulletin: ORI.650.2
February 2019